

Spot.Mate

101 book
2026

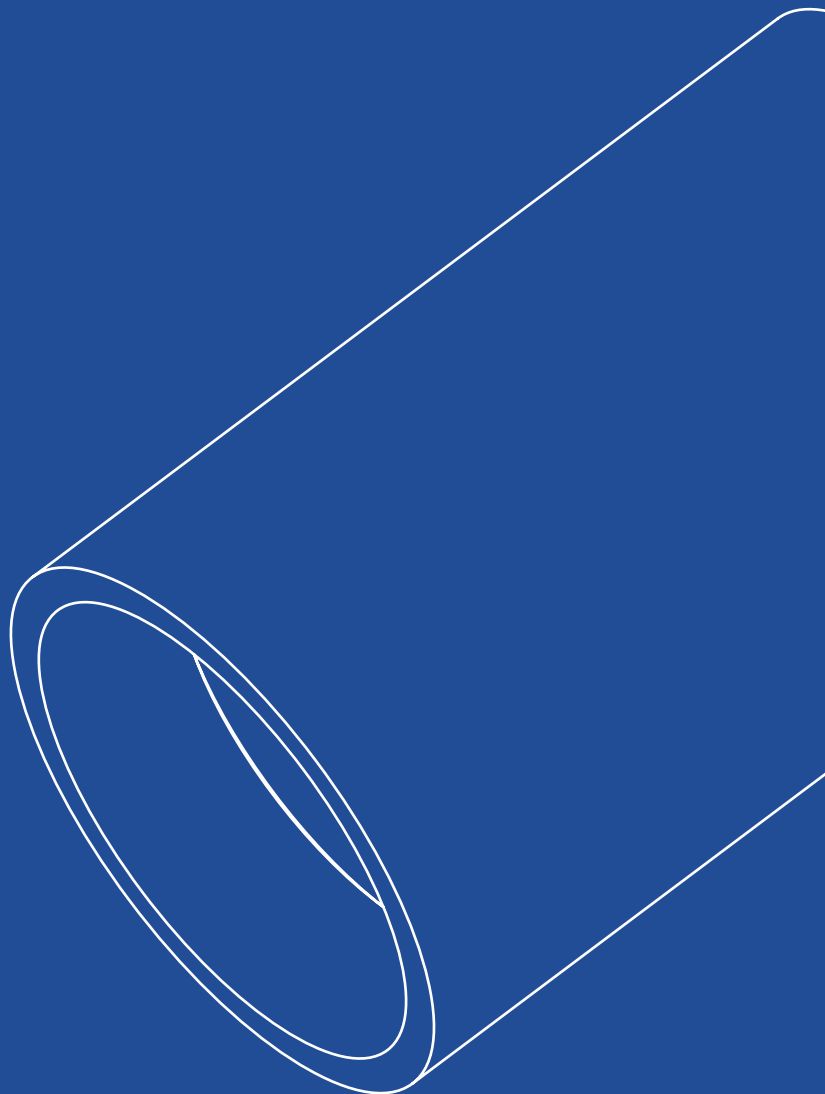

Folio Spot.Mate 2026

 FOLIO®

)00 Index

)01	Spot.Mate system	4)04	Thin.15	50
	01.01 Folio unified architecture	10)05	Light.26	62
	01.02 Spot.Mate families	12)06	Midi.40	86
)02	Peculiarities	18)07	Bold.62	110
	02.01 Snap-in	22)08	Material integration	124
	02.02 Trim // Trimless	28			
	02.03 Plug-in	34			
)03	Aesthetic	40			
	03.01 Finishes	44			
	03.02 Accessories	48			

Spot.Mate system

-)01.01 Folio unified architecture
-)01.02 Spot.Mate families

Spot.Mate system

The Spot.Mate system is a highly versatile range of architectural spotlights, meticulously designed to meet the most diverse architectural and lighting needs through a philosophy of precision engineering and absolute modularity.

Entirely crafted in Italy and CNC-machined from solid aluminium, this comprehensive collection is articulated in four distinct sizes: Thin.15, Light.26, Midi.40, and Bold.62, each offering multiple advanced features and movement possibilities to support creative freedom.

Every product is entirely customizable, ensuring bespoke integration that perfectly suits the specific aesthetic and functional requirements of any project.

As an integral part of the Folio unified architecture, all Spot.Mate fixtures are powered by a 24V supply and utilize Nichia LEDs.

The collection is further defined by distinctive peculiarities that grant unprecedented versatility.

**A versatile instrument,
designed to support
creativity and precision
in every application.**

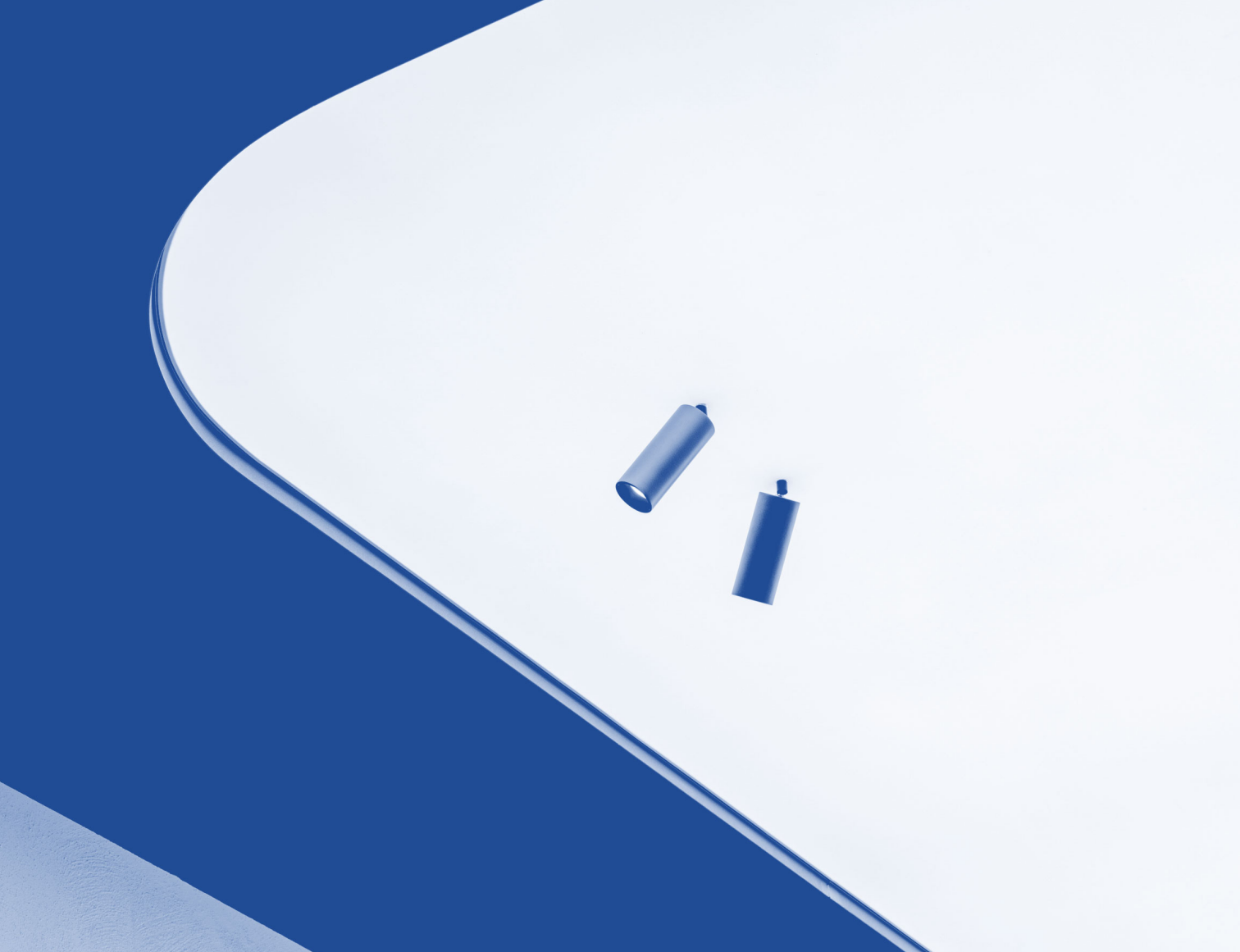

modularity
versatility
CNC accuracy

Thanks to dedicated accessories and the engineered design, the spotlights can be applied to a multitude of materials: they integrate not only into Folio products but also into drywall, furniture and, depending on the model, virtually any architectural surface.

Spot.Mate stands as a fail-safe, dynamic instrument for every design challenge.

)01.01

Folio unified architecture

All products 24Vdc.
All products Nichia LED.

Engineered for absolute simplicity and long-term reliability, the entire Folio ecosystem, including the Spot.Mate collection, shares a unified 24V supply voltage. This standardized 24V architecture significantly simplifies on-site wiring and eliminates installation errors.

Furthermore, all fixtures utilize the exact same Nichia LED engines, guaranteeing perfect color consistency across every light source in the space.

The intelligent circuitry ensures total continuity: should one unit fail, the rest of the system keeps performing without interruption, keeping the integration fully adaptable and secure.

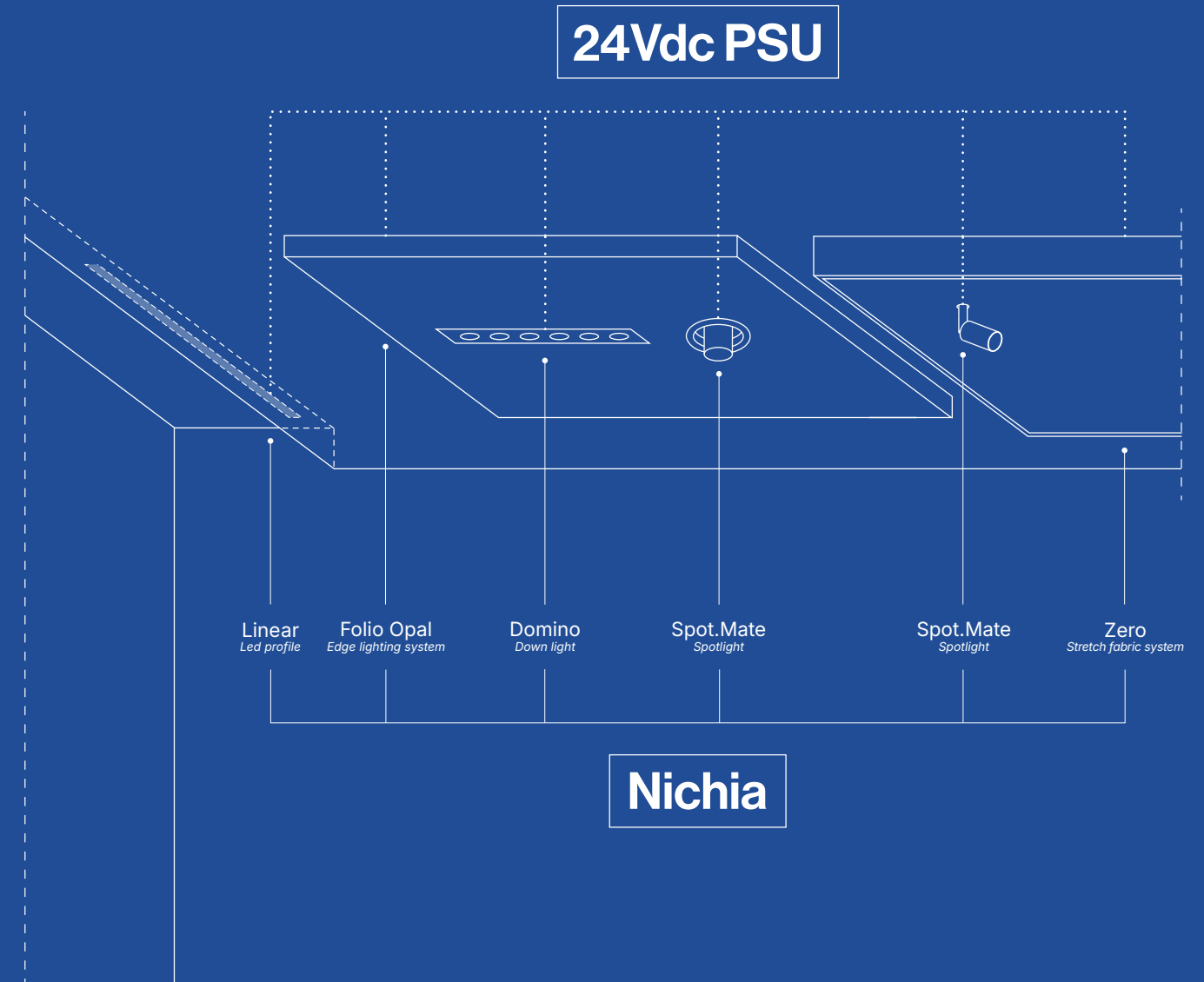

)01.02 Spot.Mate families

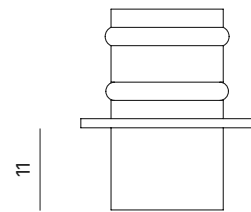

Thin.15

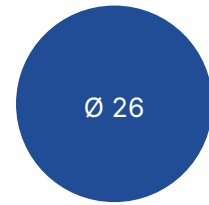
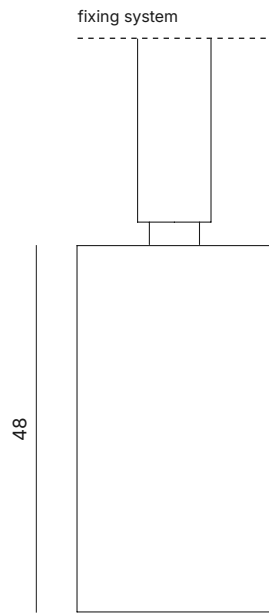

Light.26

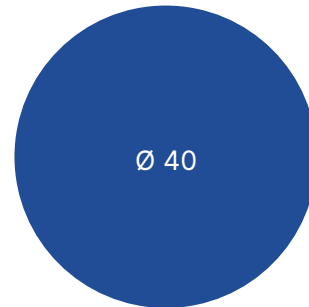
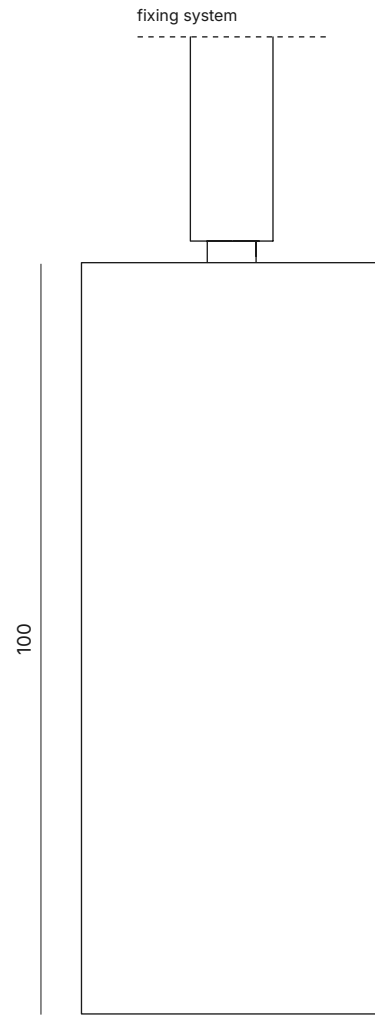

Midi.40

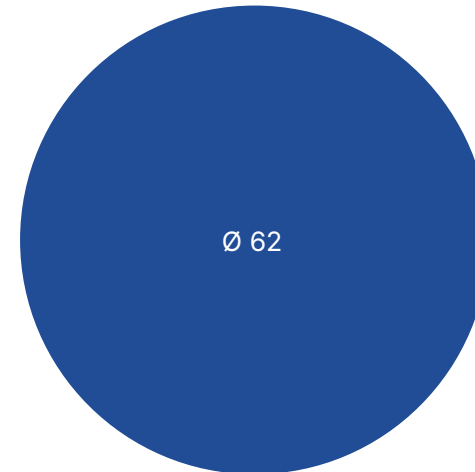
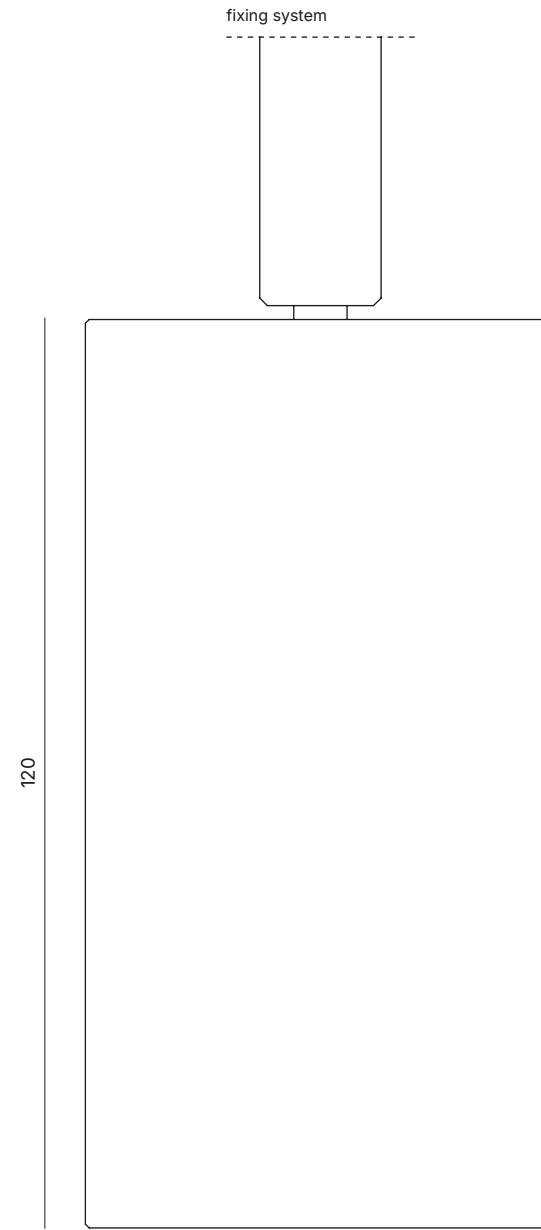

Bold.62

Thin.15
Power: 1.5 W

Light.26
Power: 2.1 W

Midi.40
Power: 6.1 W

Bold.62
Power: 12 W

Thin.15

Ø 15 mm _ power: 1.5 W

P. 50



Thin.15_adj_TR

Applications: Folio Opal, Folio Zero, furniture, drywall



Thin.15_fix_TR

Applications: Folio Opal, furniture, drywall



Thin.15_fix_TL

Applications: Folio Opal, furniture



Thin.15_track

Applications: Folio Opal, furniture

Light.26

Ø 26 mm _ power: 2.1 W

P. 62



Light.26_adj_TR

Applications: Folio Opal, Folio Zero, furniture, drywall



Light.26_adj_TL

Applications: drywall



Light.26_adj_TL_plug in_on board

Applications: Folio Opal, Folio Zero, other materials



Light.26_adj_TL_plug in

Applications: drywall



Light.26_adj_TL_recessed

Applications: furniture



Light.26_adj_TL_snap in_on board

Applications: Folio Opal, other materials



Light.26_tilt_TR

Applications: Folio Opal, furniture, drywall



Light.26_tilt_TL

Applications: drywall



Light.26_tilt_TL_on board

Applications: Folio Opal, other materials



Light.26_track

Applications: Folio Opal, furniture

Midi.40

Ø 40 mm _ power: 6.1 W

P. 86



Midi.40_adj_TR_snap in

Applications: Folio Opal, Folio Zero, furniture, drywall



Midi.40_adj_TL_snap in

Applications: drywall



Midi.40_adj_TL_plug in_on board

Applications: Folio Opal, furniture, drywall, other materials



Midi.40_adj_TL_plug in

Applications: drywall

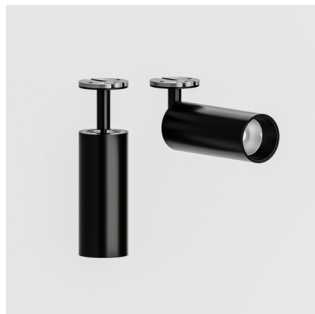

Midi.40_adj_TL_recessed

Applications: furniture



Midi.40_adj_TL_snap in_on board

Applications: Folio Opal, other materials



Midi.40_tilt_TR

Applications: Folio Opal, furniture, drywall



Midi.40_tilt_TL

Applications: drywall



Midi.40_tilt_TL_on board

Applications: Folio Opal, other materials



Midi.40_track

Applications: Folio Opal, furniture

Bold.62

Ø 62 mm _ power: 12 W

P. 110



Bold.62_adj_TR_snap in

Applications: Folio Opal, Folio Zero, Furniture, drywall



Bold.62_adj_TL_snap in

Applications: drywall

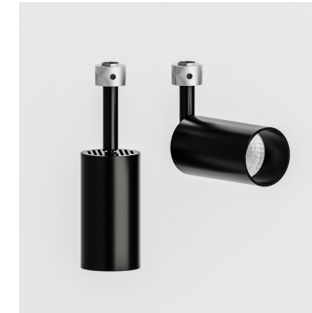

Bold.62_adj_TL_plug in_on board

Applications: Folio Opal, Folio Zero, other materials



Bold.62_adj_TL_plug in

Applications: drywall



Bold.62_adj_TL_snap in_on board

Applications: Folio Opal, other materials

Peculiarities

-)02.01 Snap-in
-)02.02 Trim // Trimless
-)02.03 Plug-in

)02 Peculiarities

Spot.Mate redefines architectural flexibility through three core engineering innovations: Snap-in, Trim// Trimless and Plug-in technologies.

The Snap-in system allows the fixture to transform from an adjustable to a fixed spotlight with a simple manual gesture.

The Trim // Trimless peculiarity means that a single spotlight can be installed as a Trim version across various materials, or become a fully Trimless solution, specifically for drywall applications, simply by adding a dedicated application tool.

The Plug-in technology, on the other hand, offers an incredibly sleek aesthetic where only the stem emerges from the installation surface; furthermore, being completely removable, the optical modules can be easily interchanged.



Snap-in

snap-in
trim // trimless
plug-in



Trim // Trimless



Plug-in

)02.01 Snap-in

02.01

Snap.in

(convertible)

Minimal in form, dynamic by nature.

The Snap-in technology grants the Spot.Mate the unique ability to transform its functionality through a few simple gestures. A single product is highly multifunctional: it can act as a fully adjustable spotlight for precise accent lighting, provide zenithal illumination, or, by pushing the optical cylinder upwards, become a compact fixed fixture where the stem is completely concealed.

This seamless transition allows lighting designers to switch between quiet integration and expressive accent lighting with absolute control, always maintaining the clean aesthetics and mechanical precision of the Spot.Mate system.

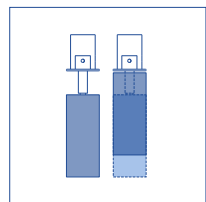
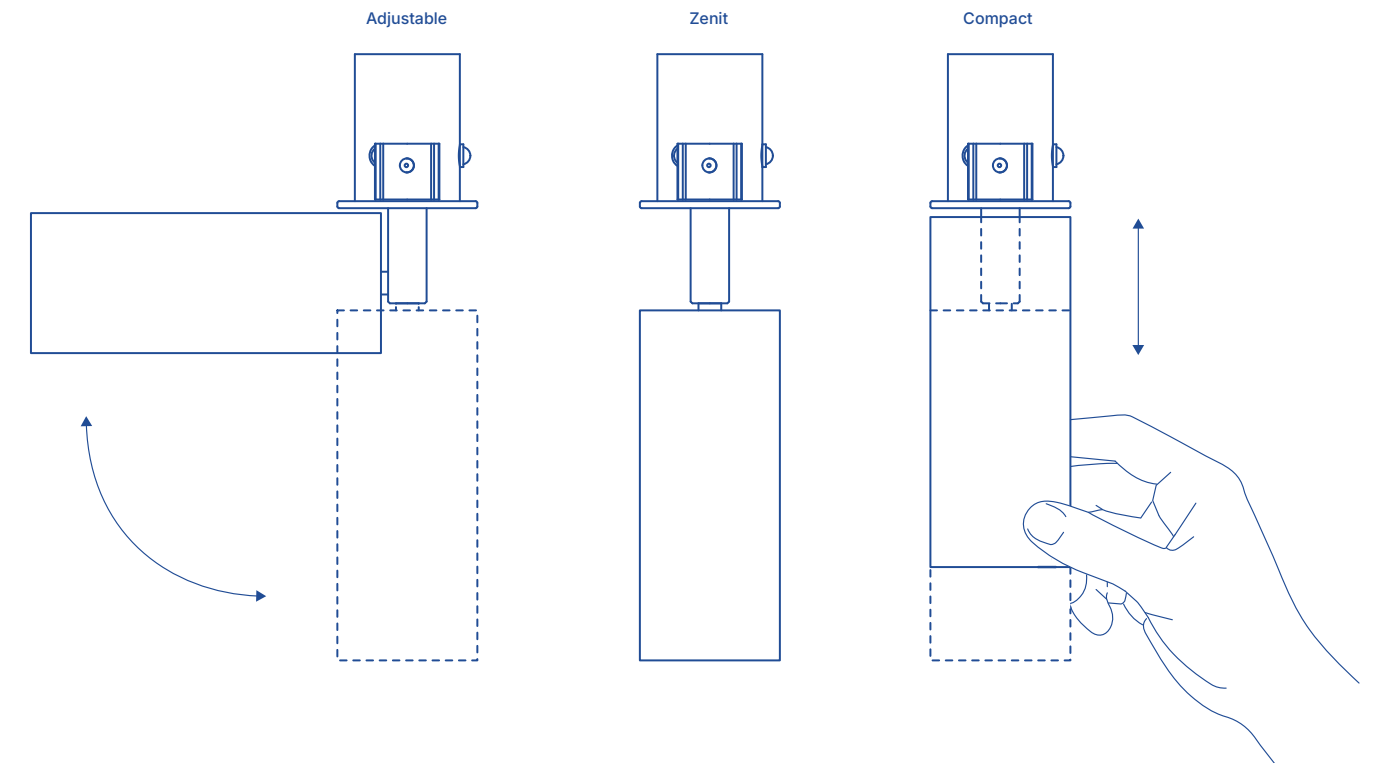

Visualization of the three possible configurations of a Snap-in Spot.Mate



Visualization of the three possible configurations of a Snap-in Spot.Mate

(convertible)

03.01

Snap.in



Focus: adj. → zenit



Focus: zenit → compact



Light.26_adj_TL_snap in_on board

Ø 26 mm
Power: 2.1 Watt

Applications: Folio Opal, other materials



Midi.40_adj_T_snap in

Ø 40 mm
Power: 6.1 Watt

Applications: Folio Opal, Folio Zero, furniture, drywall



Midi.40_adj_TL_snap in

Ø 40 mm
Power: 6.1 Watt

Applications: drywall



Midi.40_adj_TL_snap in_on board

Ø 40 mm
Power: 6.1 Watt

Applications: Folio Opal, Folio Zero, other materials

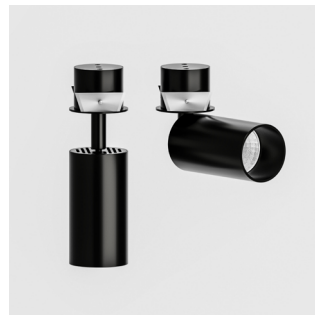

Bold.62_adj_T_snap in

Ø 62 mm
Power: 12 Watt

Applications: Folio Opal, Folio Zero, Furniture, drywall



Bold.62_adj_TL_snap in

Ø 62 mm
Power: 12 Watt

Applications: drywall



Bold.62_adj_TL_snap in_on board

Ø 62 mm
Power: 12 Watt

Applications: Folio Opal, other materials

(versatile)

One system, dual aesthetics.

The Trim // Trimless feature allows a single Spot.Mate fixture to adapt effortlessly to the architectural language of the space.

As a trim version, it can be installed across a wide variety of materials. By simply adding a dedicated trimless application tool, the exact same spotlight transforms into a fully invisible, trimless solution designed exclusively for drywall ceilings.

This reversibility is achieved with precise simplicity: for the Light.26, the tool is directly applied, whereas for the Midi.40 and Bold.62 sizes, the transformation requires only the removal of a retaining spring before inserting the accessory.

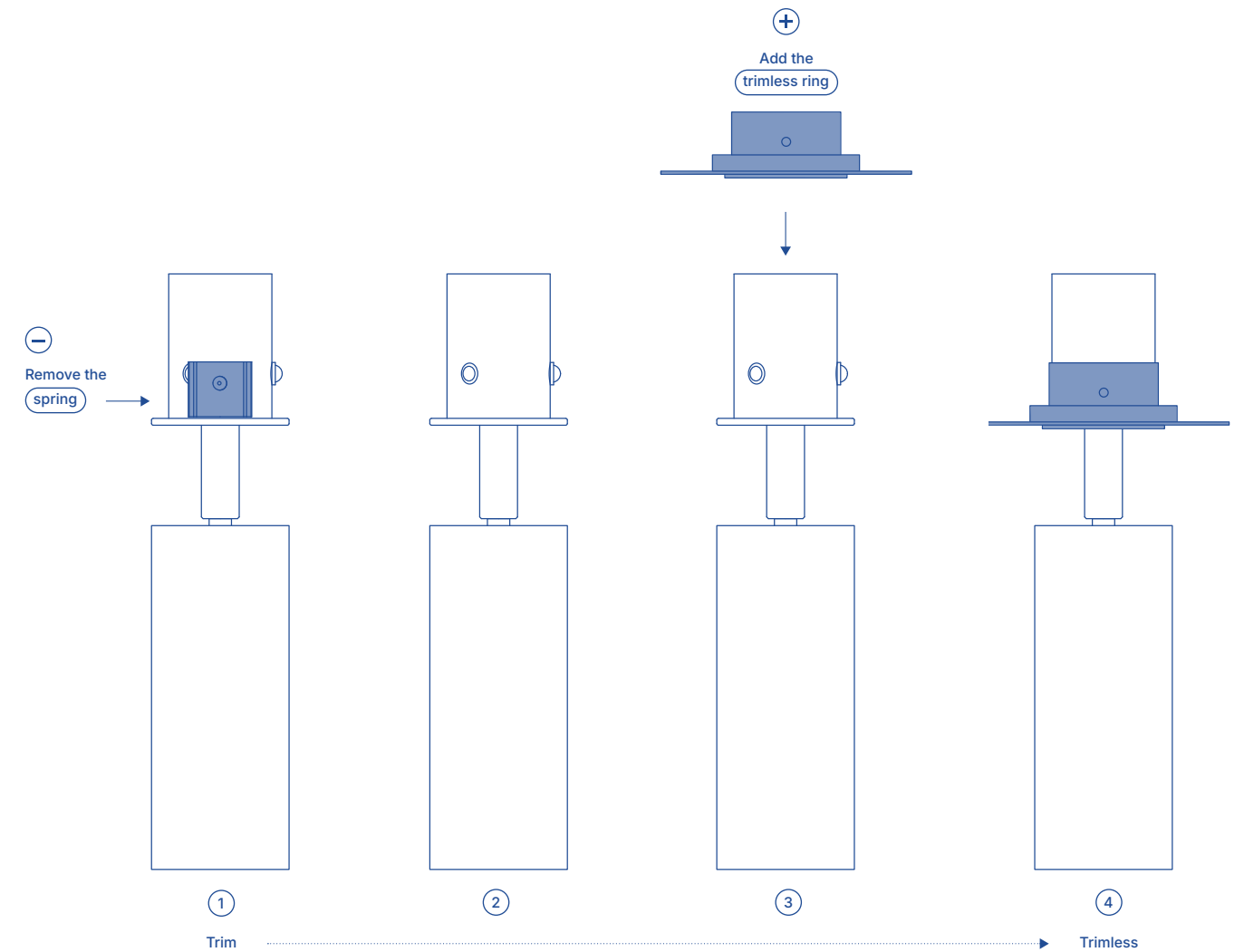
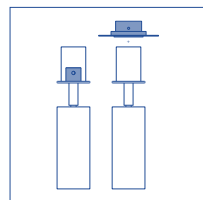

Visualization of the transition from trim to trimless configuration (Midi.40 and Bold.62)

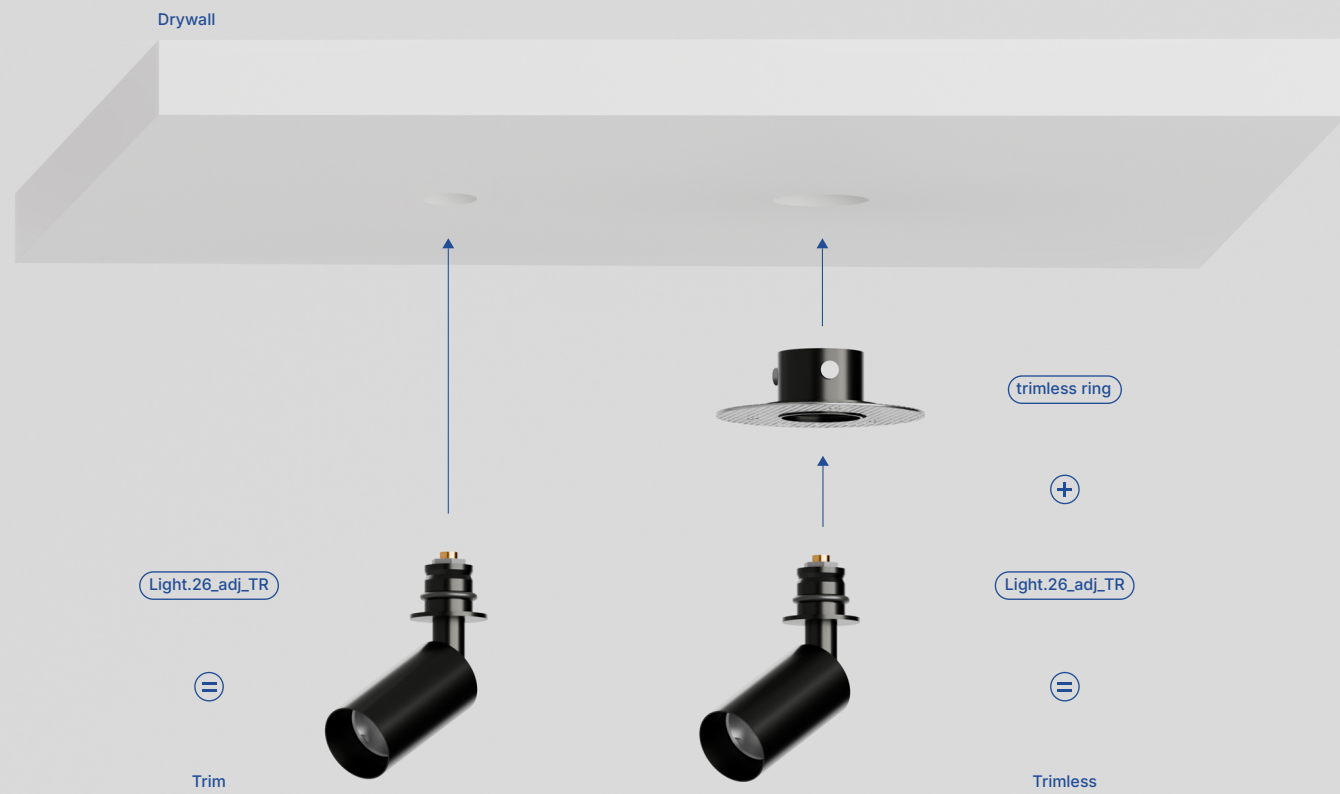

Visualization of the conversion from trim to trimless by adding a trimless ring (Light.26)

Light.26

(versatile)



Visualization of the conversion from trim to trimless by adding a trimless ring and removing the spring (Midi.40)

Midi.40
Bold.62

Characteristic of



Light.26_adj_TR

Ø 26 mm
Power: 2.1 Watt

*Applications: Folio Opal, Folio Zero,
furniture, drywall*



Light.26_adj_TL

Ø 26 mm
Power: 2.1 Watt

Applications: drywall

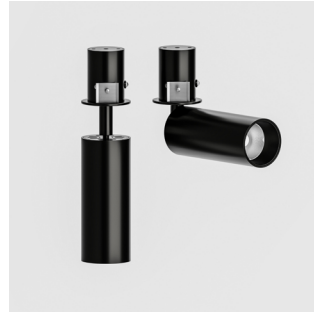

Midi.40_adj_TR_snap in

Ø 40 mm
Power: 6.1 Watt

*Applications: Folio Opal, Folio
Zero, furniture, drywall*



Midi.40_adj_TL_snap in

Ø 40 mm
Power: 6.1 Watt

Applications: drywall



Bold.62_adj_TR_snap in

Ø 62 mm
Power: 12 Watt

*Applications: Folio Opal, Folio Zero,
furniture, drywall*



Bold.62_adj_TL_snap in

Ø 62 mm
Power: 12 Watt

Applications: drywall

02.03 Plug-in

Designed to evolve with the architecture.

The Plug-in system redefines interchangeability by allowing the entire spot to be completely removed from its docking system.

Aesthetically, it creates a pure, minimalist look where only the sleek stem emerges from the surface material. Practically, the removable nature of the system means the optical modules can be effortlessly exchanged.

Stem sizes are standardized for maximum versatility: the Light.26 and Midi.40 share the same stem diameter, making them fully interchangeable with one another while the Bold.62 features a thicker stem dedicated exclusively to its high-power modules.

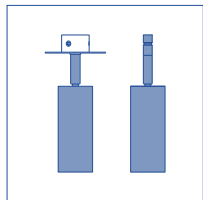

(sleek) (interchangeable)

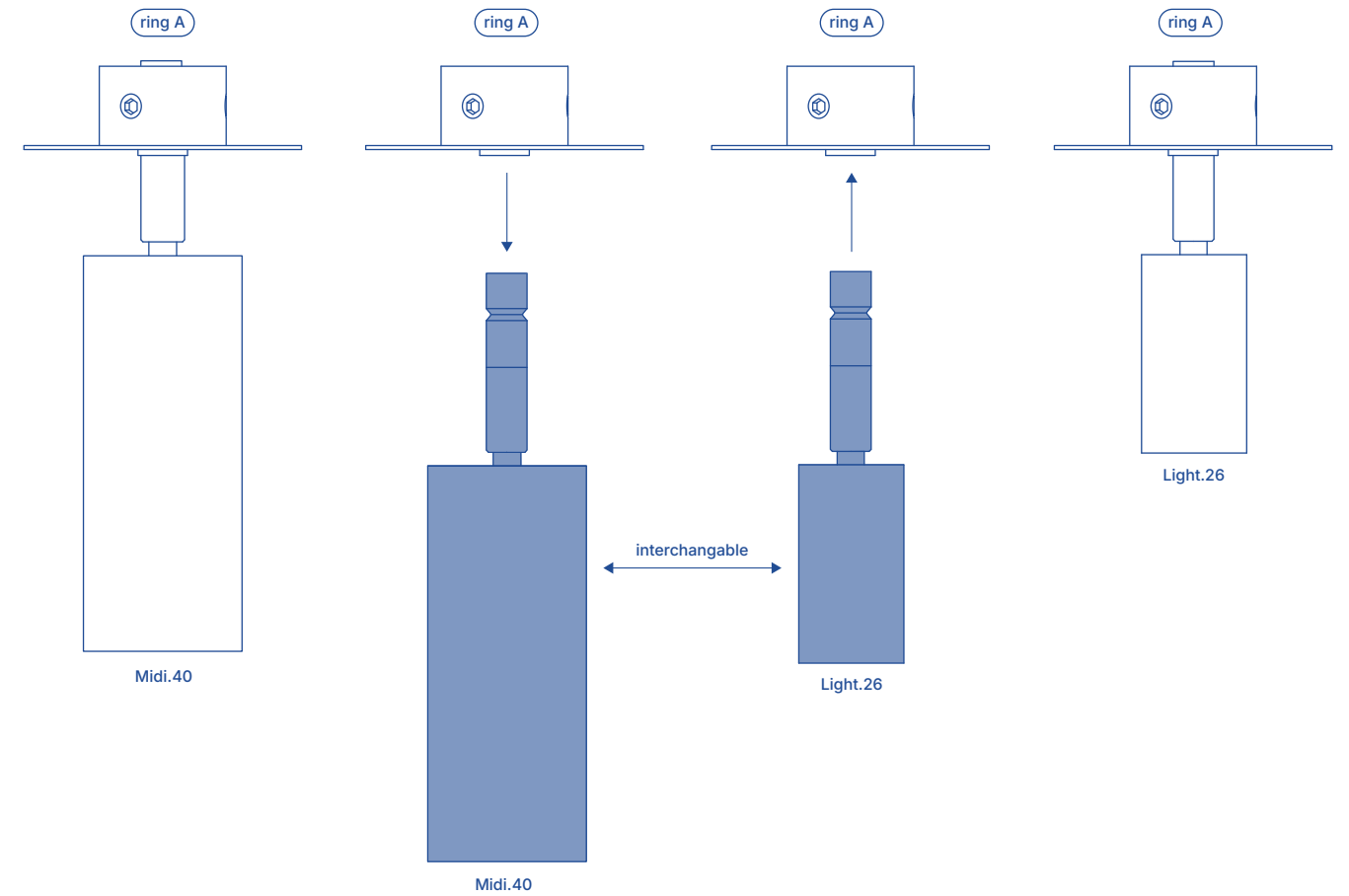

Visualization of the Plug-in interchangeability (Midi.40 and Light.26)

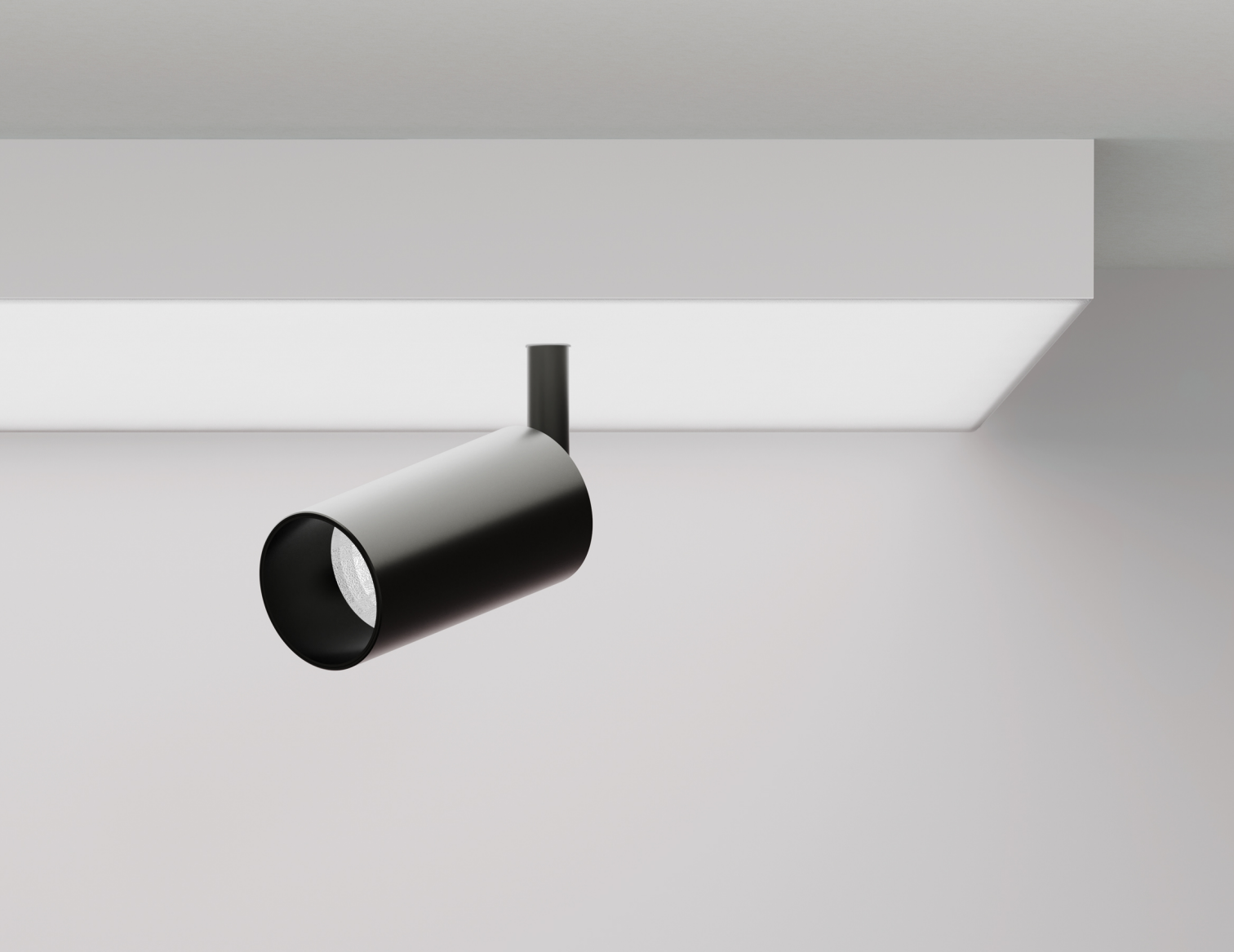

Visualization of a Spot.Mate Plug-in installation on a Folio Zero, where only the stem is visible.

(sleek)

(interchangable)

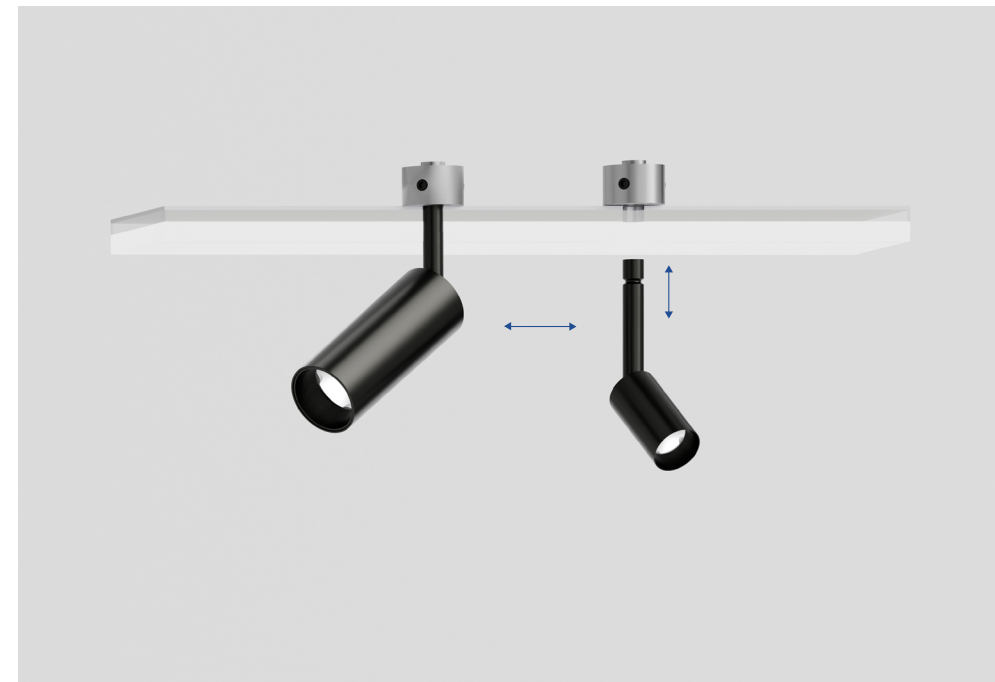

Visualization of a Plug-in installation on a Folio Opal, featuring interchangeable Midi.40 and Light.26 modules

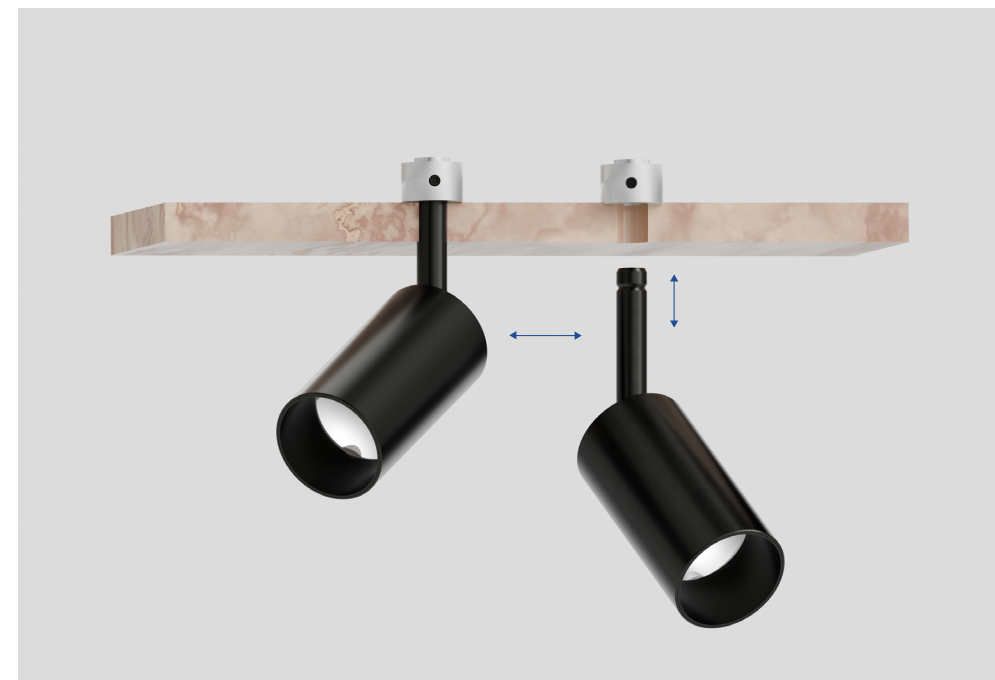

Visualization of a Plug-in installation on any material, featuring interchangeable Bold.62 modules

Characteristic of



Light.26_adj_TL_plug in_on board

Ø 26 mm
Power: 2.1 Watt

*Applications: Folio Opal, Folio Zero,
other materials*



Light.26_adj_TL_plug in

Ø 26 mm
Power: 2.1 Watt

Applications: drywall

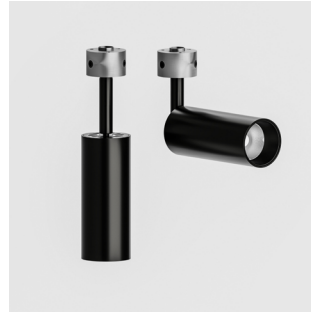

Midi.26_adj_TL_plug in_on board

Ø 26 mm
Power: 6.1 Watt

Folio Opal, furniture, drywall



Midi.40_adj_TL_plug in

Ø 40 mm
Power: 6.1 Watt

Applications: drywall

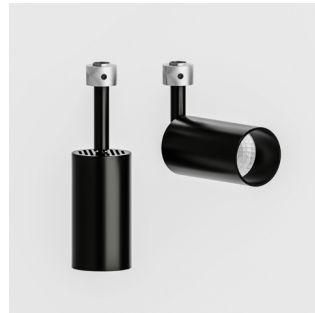

Bold.62_adj_TL_plug in_on board

Ø 62 mm
Power: 12 Watt

*Applications: Folio Opal, Folio Zero,
other materials*



Bold.62_adj_TL_plug in

Ø 62 mm
Power: 12 Watt

Applications: drywall

Aesthetic

-)03.01 Finishes
-)03.02 Accessories

)03

Aesthetic

Where material meets precision.

Spot.Mate is crafted entirely from solid aluminum, chosen for its thermal performance and its ability to achieve absolute CNC-machining accuracy.

To complement any interior, the collection offers an extensive palette of surface treatments. For perfect architectural camouflage or specific visual statements, the fixtures can be custom-painted in any standard RAL, NCS or Pantone color.

Alternatively, the metal can be enhanced with Polished, Brushed or Galvanic finishes for depth, reflection and refined metallic character.

Every detail is engineered to elevate the light.

RAL _ NCS _ Pantone
oxidated finish
polished finish
brushed finish



Visualization of three different finishes

)03.01 Finishes

03.01

Finishes

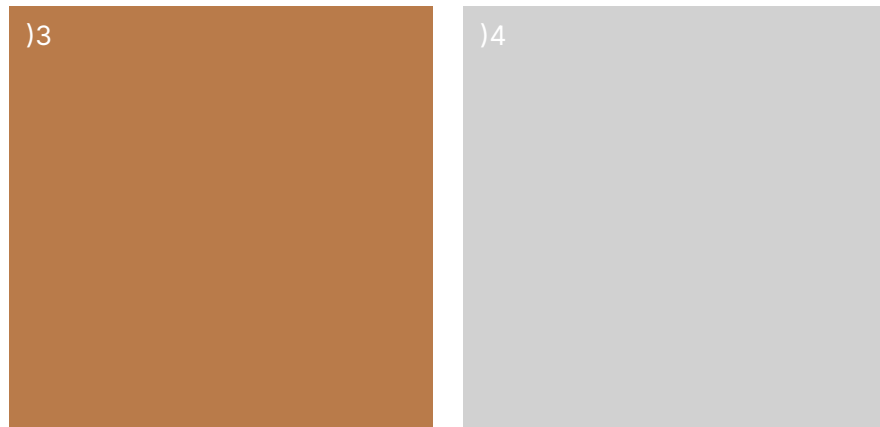
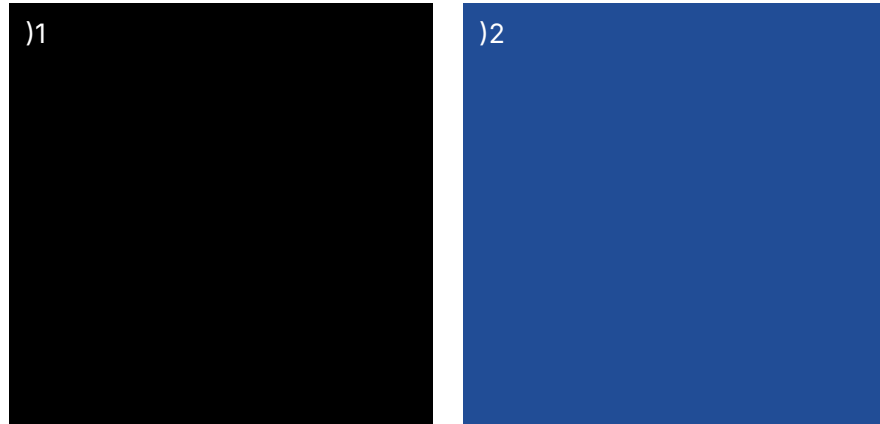

RAL _ NCS _ Pantone

-)1 e.g.
-)2 e.g.
-)3 e.g.
-)4 e.g.

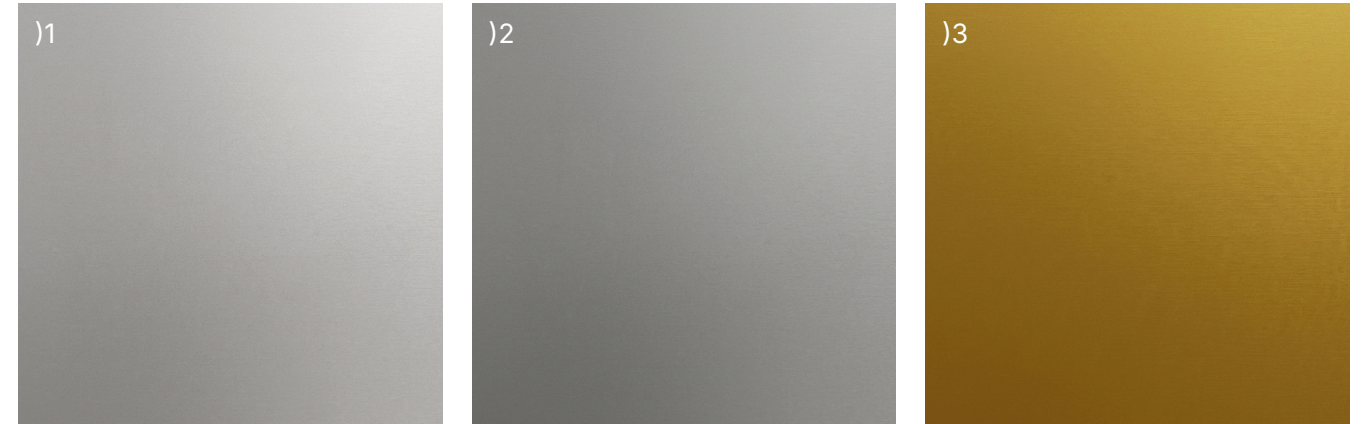

Oxidized

-)1 Aluminium
-)2 Steel
-)3 Brass
-)4 Copper
-)5 Champagne
-)6 Bronze

)03.01 Finishes

03.01

Finishes

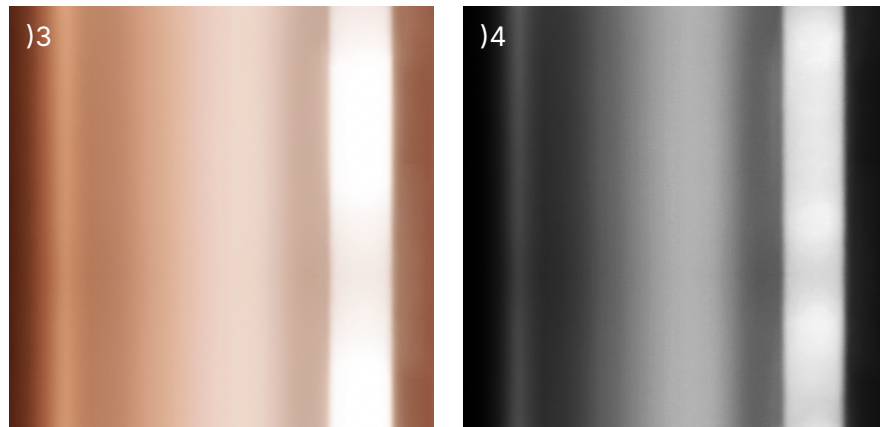
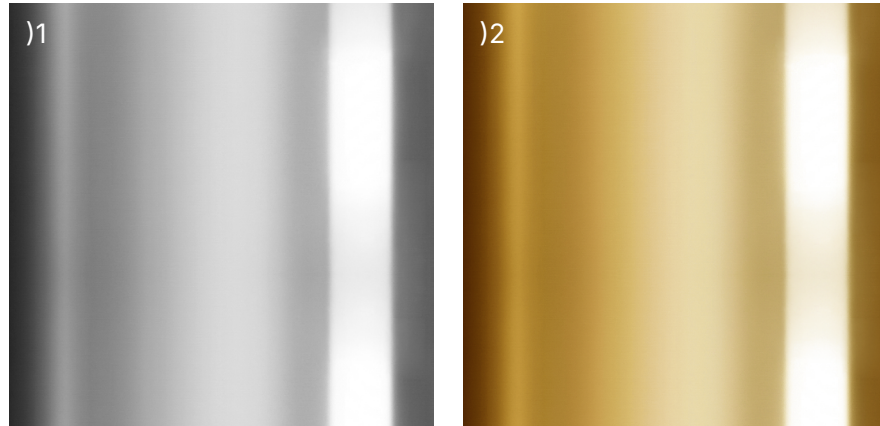

Polish

-)1 Chrome
-)2 Brass
-)3 Copper
-)4 Black Nickel

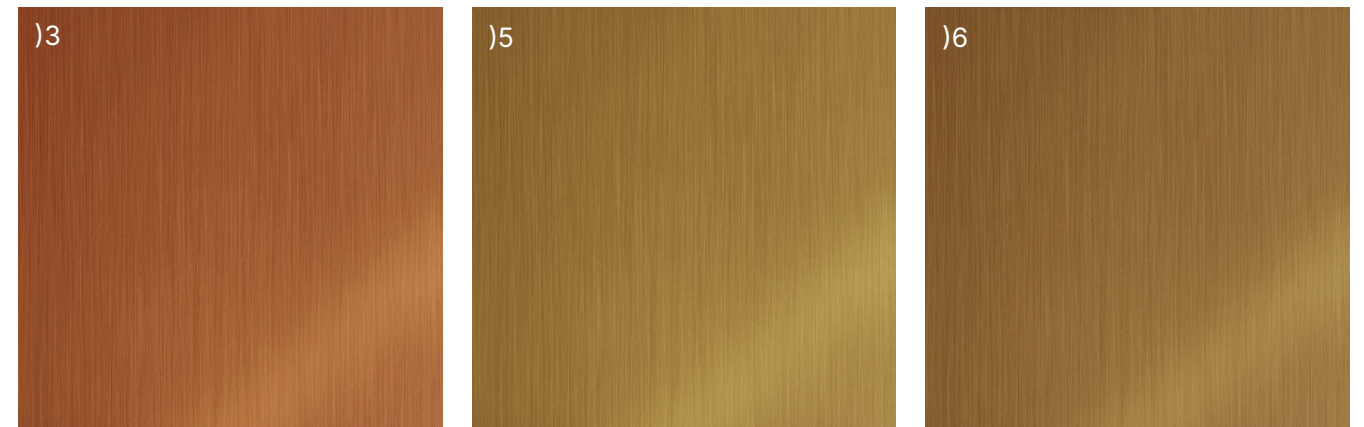
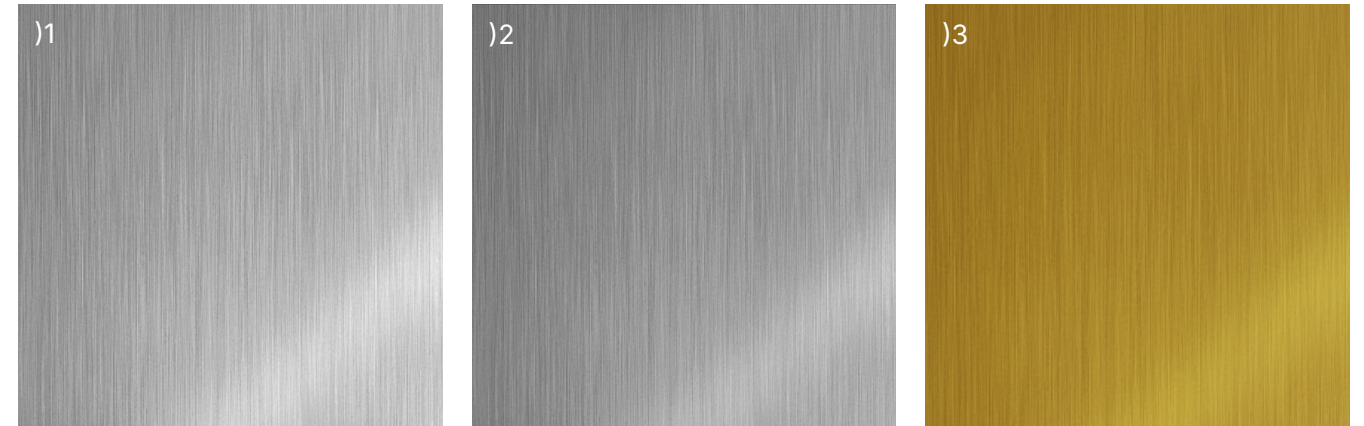

Brushed

-)1 Aluminium
-)2 Steel
-)3 Brass
-)4 Copper
-)5 Champagne
-)6 Bronze

)03.02 Accessories

03.01

Finishes

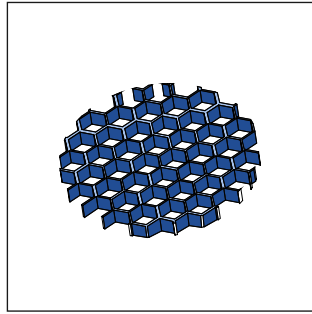

Honeycomb

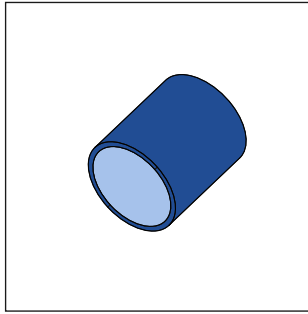

Snoot

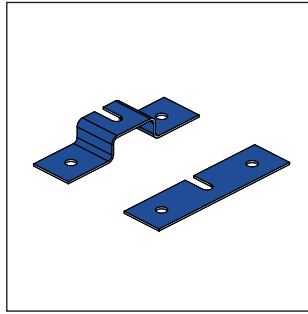

Metallic bracket
Thin.15_fix_TL

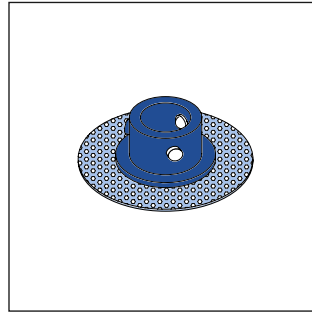

Trimless ring
Light.26

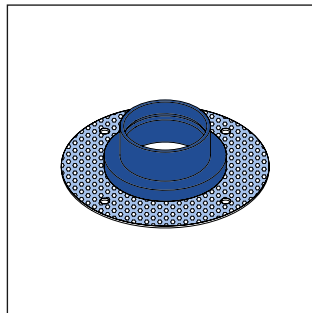

Trimless ring
Midi.40

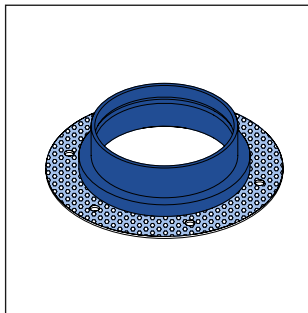

Trimless ring
Bold.62

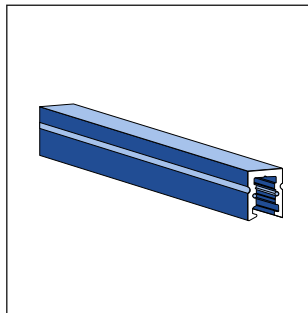

Kore track
Thin.15

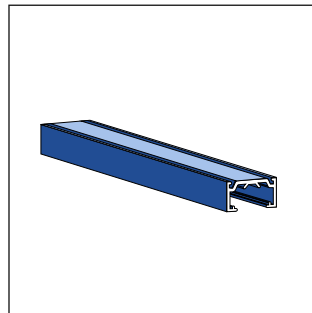

Micro track
Midi.40, Bold.62



Thin.15

)04 Thin.15

The perfect blend of miniaturization and performance, this micro-spot features an ultra-compact diameter of 15 mm. Designed for discreet integration, the Thin.15 is available in both adjustable and fixed solutions, offering both trim and trimless installation options to guarantee immediate customization with minimal visual impact.

)Light source

LED type:	Nichia
LED Amperage:	500 mA
LED Duration:	50 000 h.
Power:	1.5 W
Delivered Lumen:	145 lm
Efficacy:	96.6 lm/W
CRI:	>90
R9:	>80
TM30:	Rf: 91 Rg: 100
SDCM:	2
Color temperature (CCT):	2700K, 3000K, 3500K, 4000K <i>on request: 2000K, 2200K, 2500K, 5000K</i>

)Optics

Optic Type:
Beam Angle (BA°):

lens

15°



25°



35°

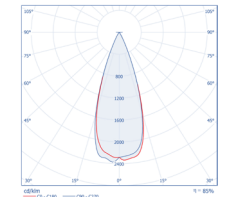
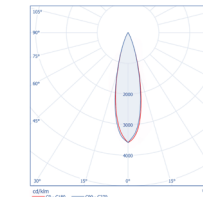
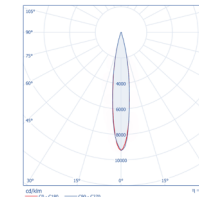

)Electrical

Voltage:	24VDC
Class:	Class 3 24V
Driver:	DC/DC 24V
Output current:	500 mA
Dimmerability:	0-10V, 1-10V, DALI, DMX, Bluetooth, PUSH



Thin.15_adj_TR

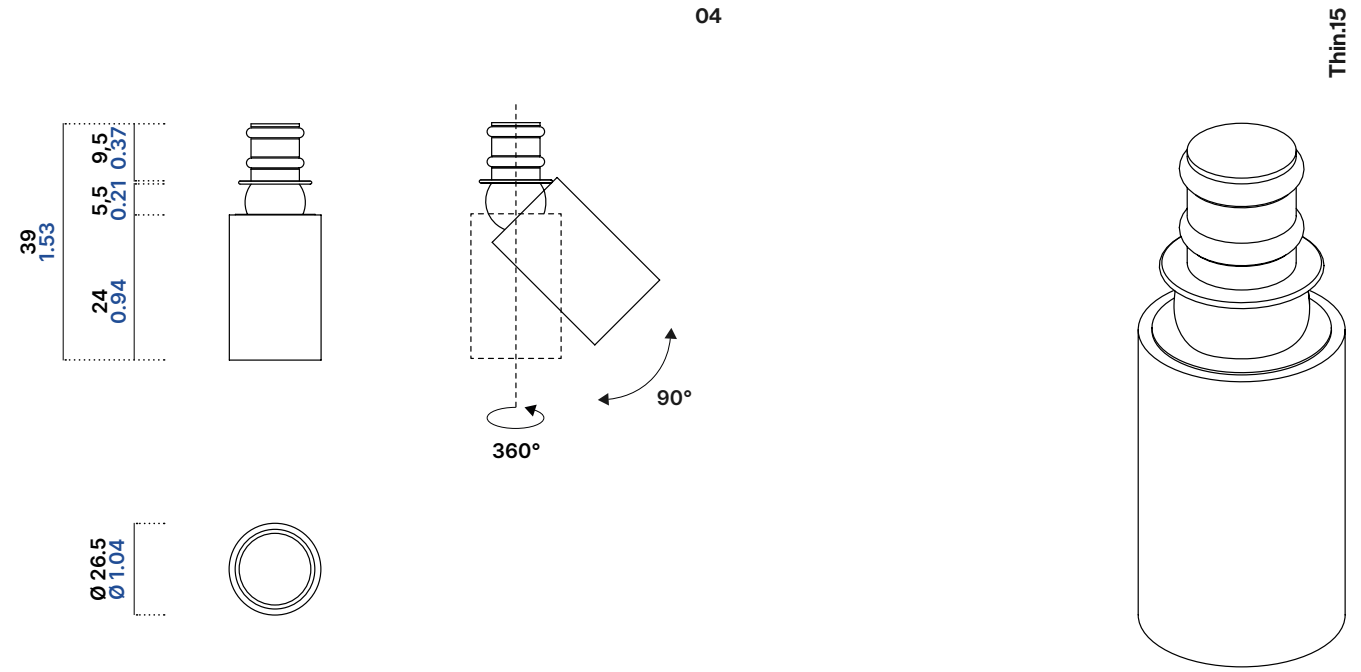

Weight

0.01 kg

Applications

Folio Opal

Folio Zero

Forniture

Drywall

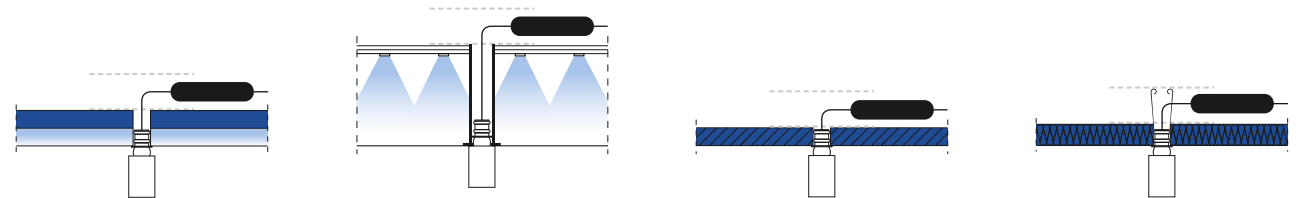

Cut out: 9.5 mm / 3.74 in



Clear volume: 20 mm / 7.87 in

Cut out: 9.5 mm / 3.74 in



Clear volume: 20 mm / 7.87 in

Cut out: 9.5 mm / 3.74 in



Clear volume: 20 mm / 7.87 in

Cut out: 9.5 mm / 3.74 in



Clear volume: 20 mm / 7.87 in

Thin.15_fix_TR

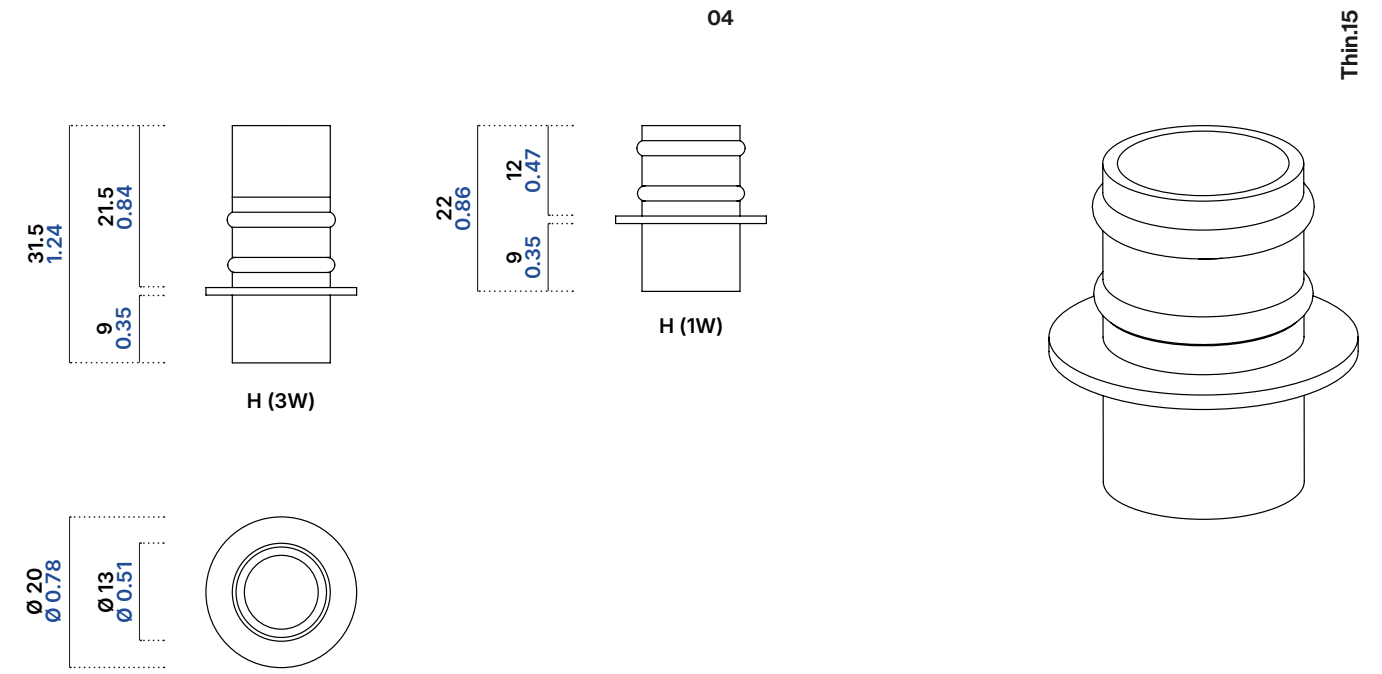

Weight

0.01 kg / 0.02 kg

Applications

Folio Opal

Forniture

Drywall

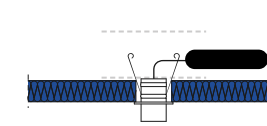
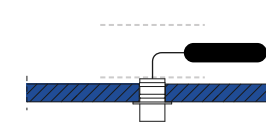
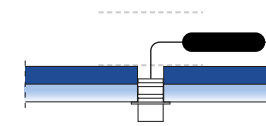

Cut out: 14.5 mm / 5.71 in



Cut out: 14.5 mm / 5.71 in



Cut out: 14.5 mm / 5.71 in



Clear volume: 30 mm / 11.81 in

Clear volume: 30 mm / 11.81 in

Clear volume: 30 mm / 11.81 in

Thin.15_adj_TL

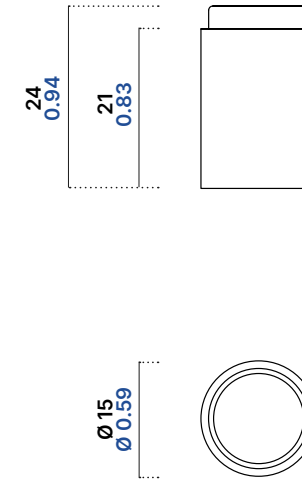

04

Thin.15

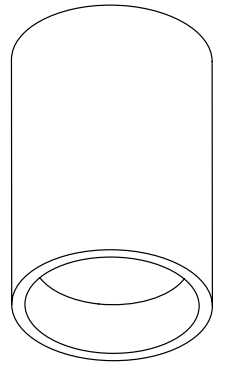

Weight

0.02 kg

Applications

Folio Opal

Forniture

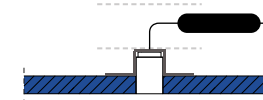
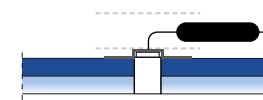

Cut out: 15 mm / 5.90 in



Cut out: 15 mm / 5.90 in



Clear volume: 25 mm / 9.84 in



Clear volume: 25 mm / 9.84 in



Thin.15_adj_track

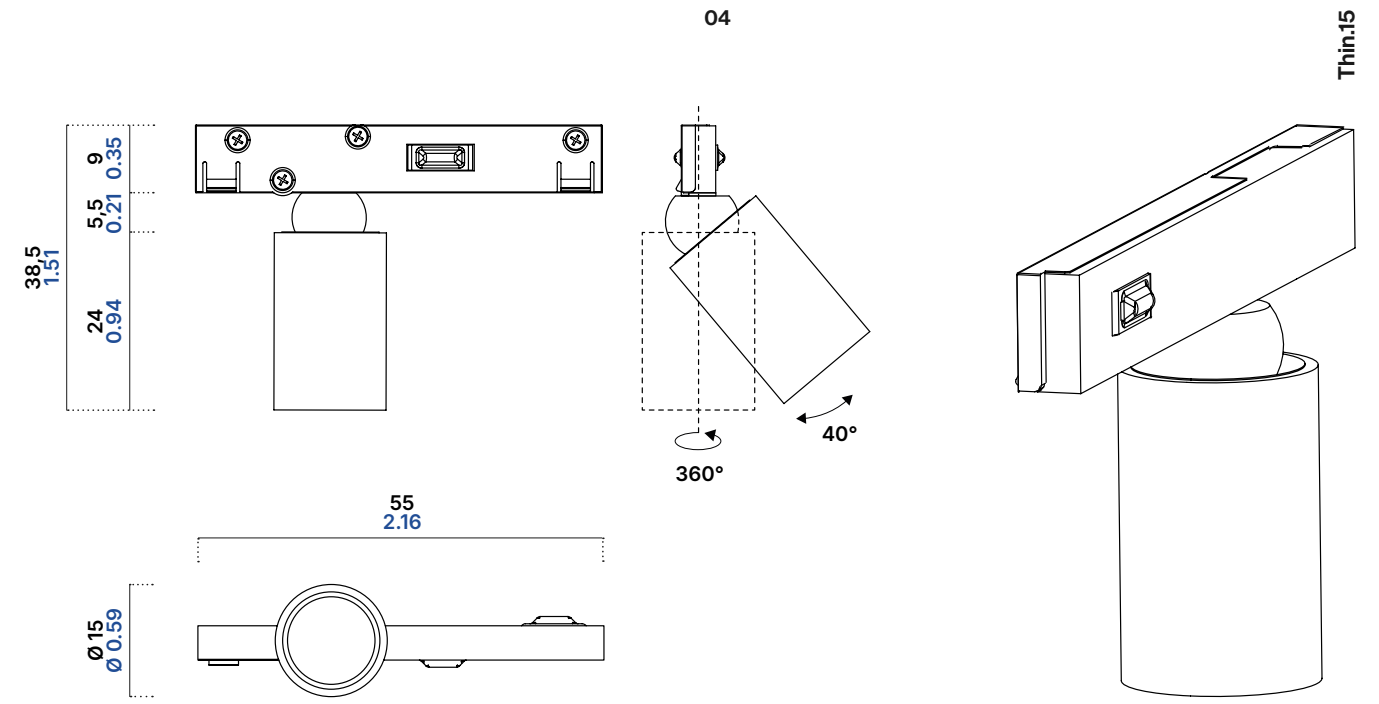

Weight

0.06 kg

Applications

Folio Opal

Forniture

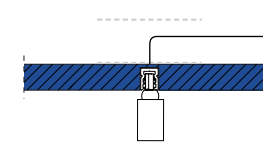
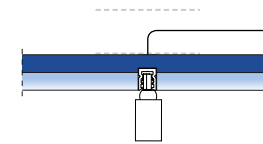

Cut out: 15 mm / 5.90 in



Cut out: 15 mm / 5.90 in



Clear volume: 25 mm / 9.84 in

Clear volume: 25 mm / 9.84 in

)04 Light.26

The ideal balance between power and understated design, this 26 mm diameter system adapts naturally to any design challenge. Within the Light.26 range, we offer specific spotlights featuring the Trim // Trimless peculiarity, others engineered with the Plug-in system and a dedicated version equipped with the innovative Snap-in technology.

)Light source

LED type:	Nichia
LED Amperage:	700 mA
LED Duration:	50 000 h.
Power:	2.1 W
Delivered Lumen:	220 lm
Efficacy:	104.8 lm/W
CRI:	>90
R9:	>50
TM30:	Rf: 91 Rg: 100
SDCM:	3
Color temperature (CCT):	2700K, 3000K, 3500K, 4000K <i>on request: 2000K, 2200K, 2500K, 5000K</i>

)Optics

Optic Type:
Beam Angle (BA°):

lens

12°

18°

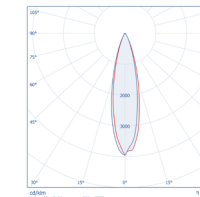
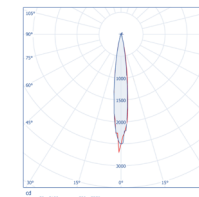

)Electrical

Voltage:	24VDC
Class:	Class 3 24V
Driver:	DC/DC 24V
Output current:	700 mA
Dimmerability:	0-10V, 1-10V, DALI, DMX, Bluetooth, PUSH



Light.26_adj_TR

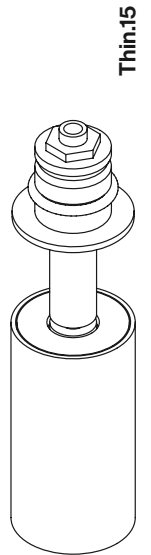
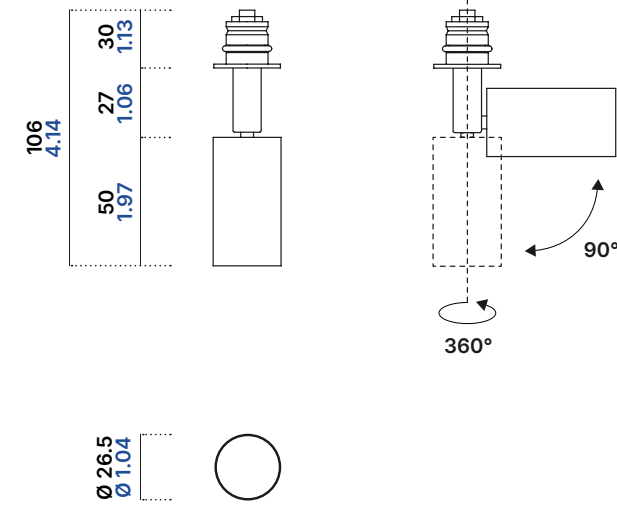

Weight

0.08 kg

Applications

Folio Opal

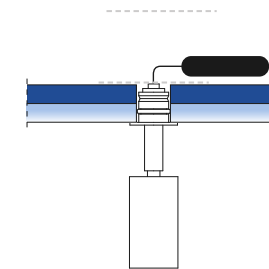

Cut out: \varnothing 18,5 mm / \varnothing 0.72 in



Clear volume: 40 mm / 1.57 in

Folio Zero

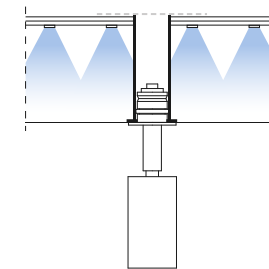

Cut out: \varnothing 18,5 mm / \varnothing 0.72 in



Clear volume: 40 mm / 1.57 in

Forniture

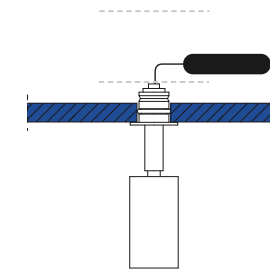

Cut out: \varnothing 18,5 mm / \varnothing 0.72 in



Clear volume: 40 mm / 1.57 in

Drywall

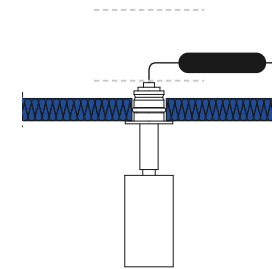

Cut out: \varnothing 18,5 mm / \varnothing 0.72 in



Clear volume: 40 mm / 1.57 in

Peculiarities

Trim // Trimless

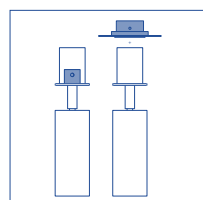

www.folio.it > Menu > Download > Datasheet > Datasheet Spot.Mate

02.01 Light.26_adj_TR

Light.26_adj_TL

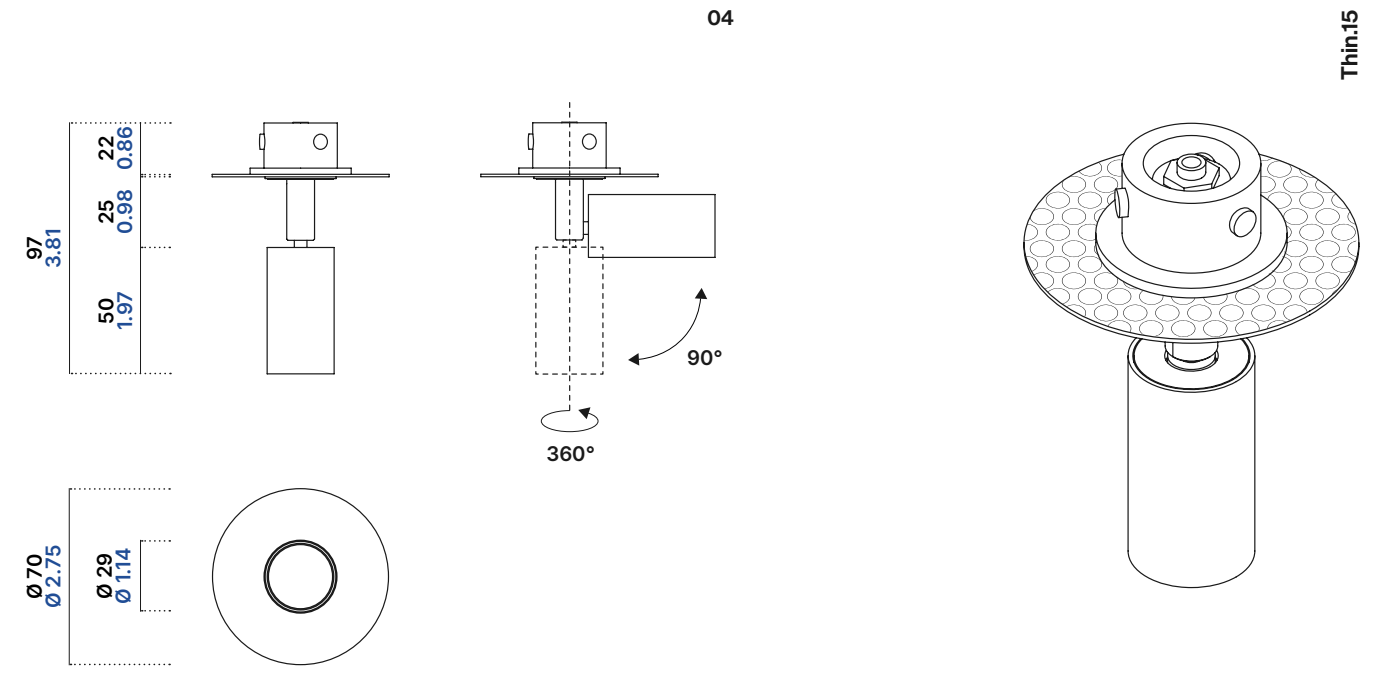

Thin:15

Weight

0.11 kg

Applications

Drywall

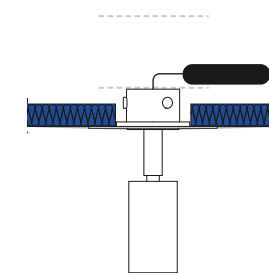

Cut out: \varnothing 40 mm / \varnothing 1.57 in



Clear volume: 40 mm / 1.57 in

Peculiarities

Trim // Trimless

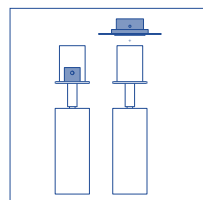

www.folio.it > Menu > Download > Datasheet > Datasheet Spot.Mate

02.02 Light.26_adj_TL

Light.26_adj_TL_plug in_on board

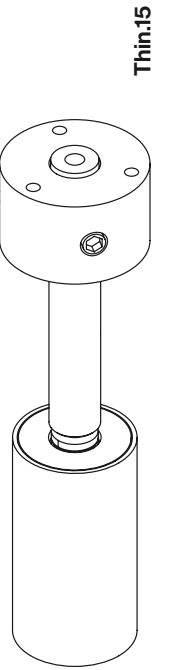
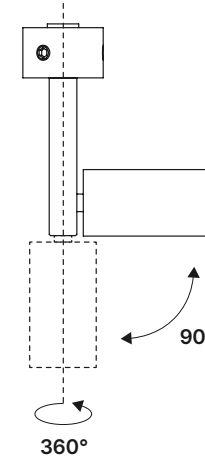
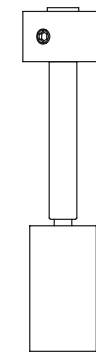
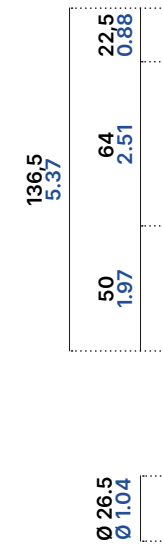

04

Thin:15

Weight

0.14 kg

Applications

Folio Opal

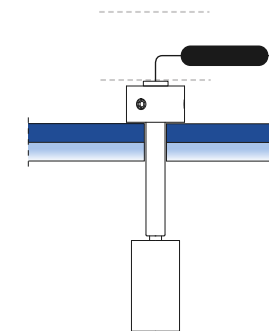

Cut out: \varnothing 11,5 mm / \varnothing 0.45 in



Clear volume: 50 mm / 1.96 in

Folio Zero

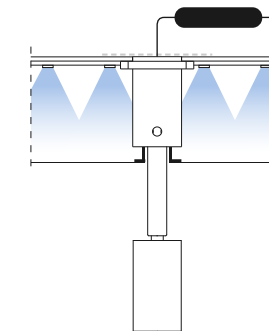

Cut out: \varnothing 11,5 mm / \varnothing 0.45 in



Clear volume: 50 mm / 1.96 in

Other Material

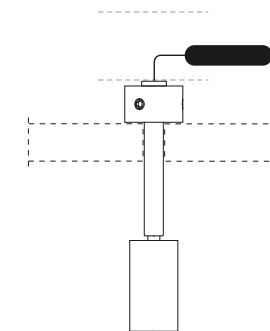

Cut out: \varnothing 11,5 mm / \varnothing 0.45 in



Clear volume: 50 mm / 1.96 in

Peculiarities

Plug-in

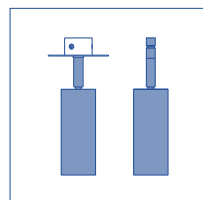

www.folio.it > Menu > Download > Datasheet > Datasheet Spot.Mate

02.03 Light.26_adj_TL_plug in_on board

Light.26_adj_TL_plug in

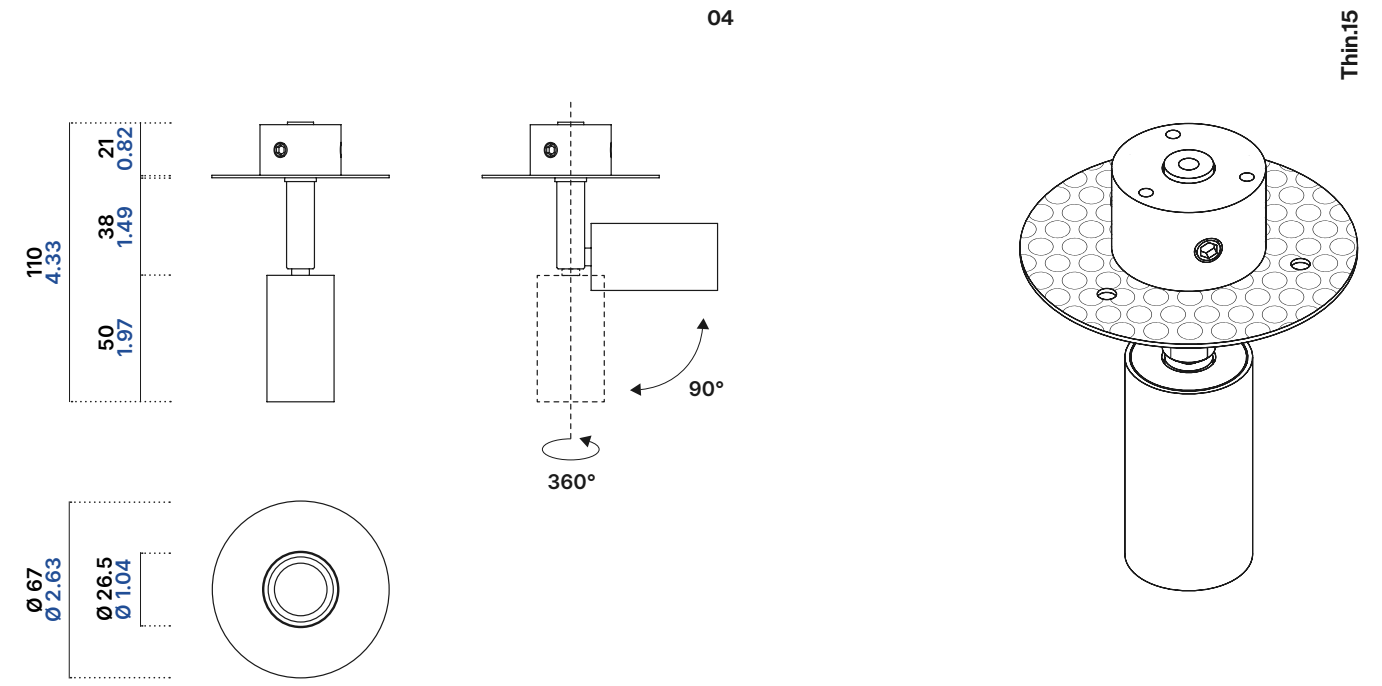

)Weight 0.14 kg

)Applications

Drywall

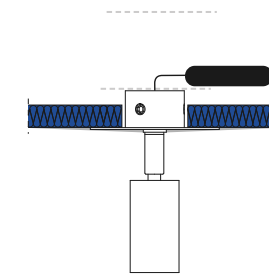

Cut out: Ø 35 mm / Ø 1.37 in



Clear volume: 40 mm / 1.57 in

)Peculiarities

Plug-in

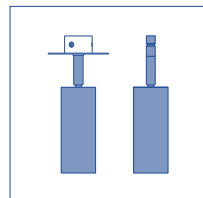

www.folio.it > Menu > Download > Datasheet > Datasheet Spot.Mate

02.04 Light.26_adj_TL_plug in

Light.26_adj_recessed

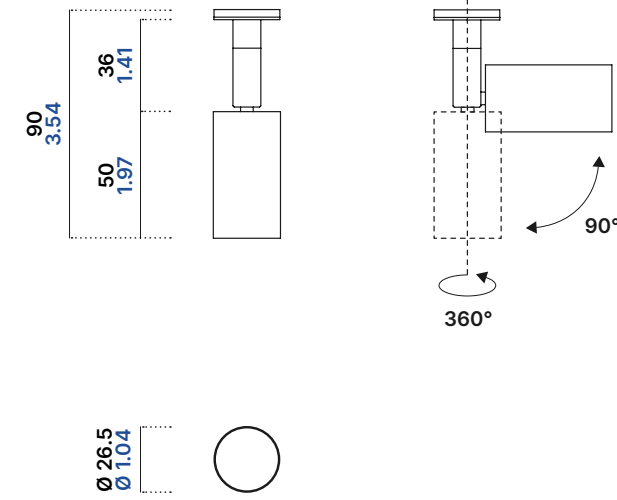

04

Thin:15

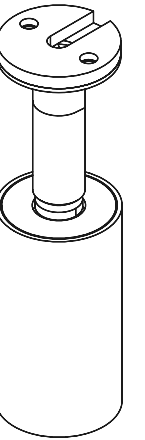

Weight

0.07 kg

Applications

Forniture

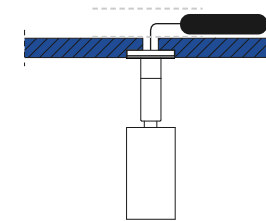

Cut out: \varnothing 26,5 mm, thk 4 mm / \varnothing 1.04 in, thk 0.15 in



Clear volume: 15 mm / 0.59 in

Light.26_adj_TL_snap in_on board

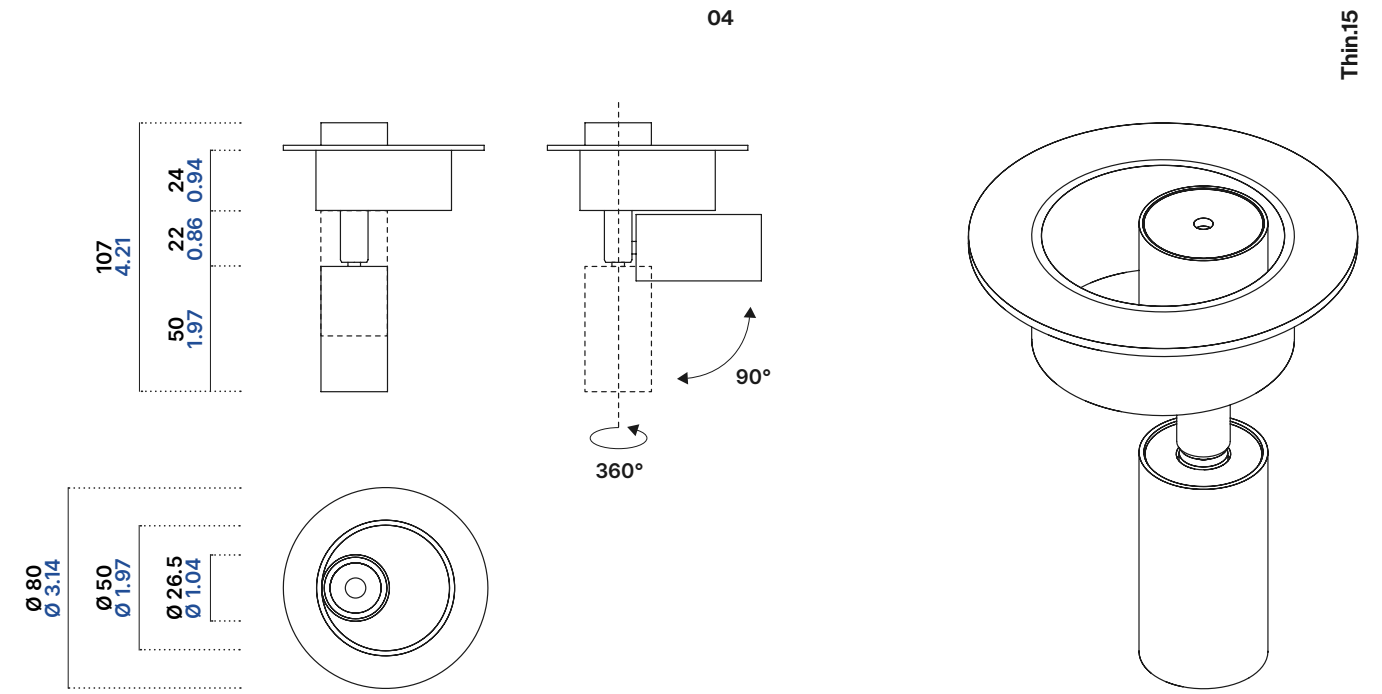
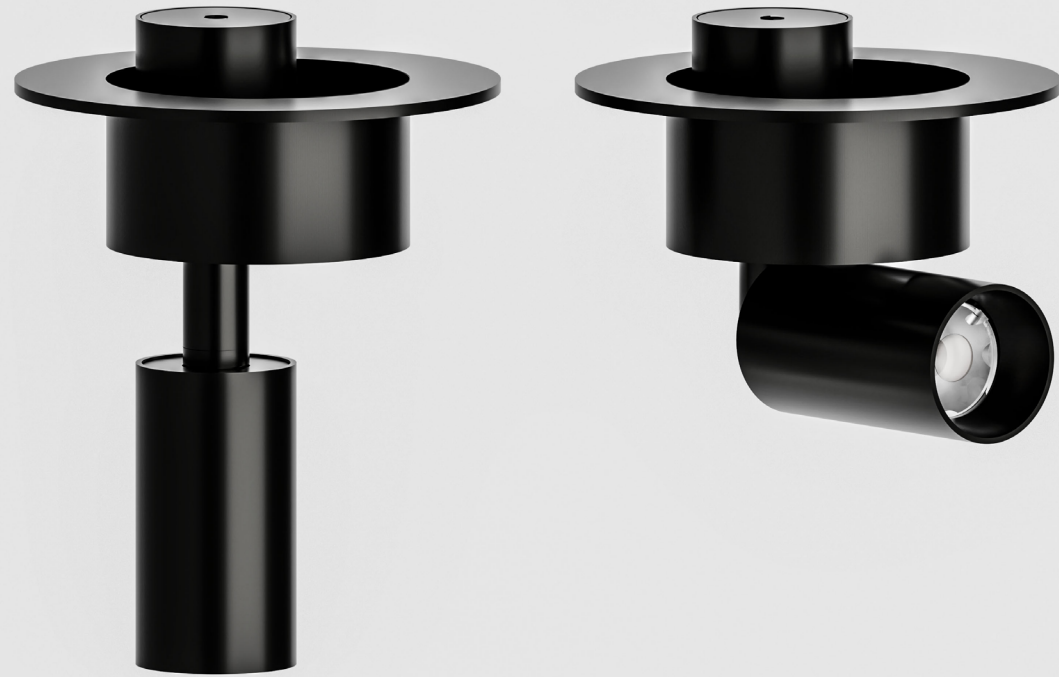

Thin:15

Weight

0.15 kg

Applications

Folio Opal

Other Material

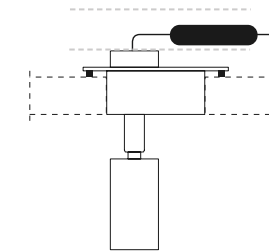
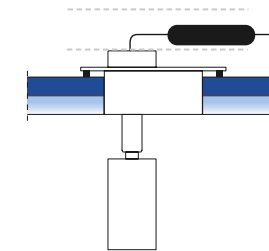

Cut out: Ø 54 mm / Ø 2.12 in

Cut out: Ø 54 mm / Ø 2.12 in

Clear volume: 30 mm / 1.18 in

Clear volume: 30 mm / 1.18 in

Peculiarities

Snap-in

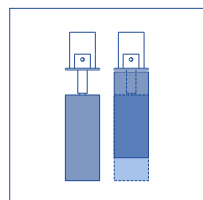

www.folio.it > Menu > Download > Datasheet > Datasheet Spot.Mate

02.06 Light.26_adj_TL_snap in_on board

Light.26_tilt_TR

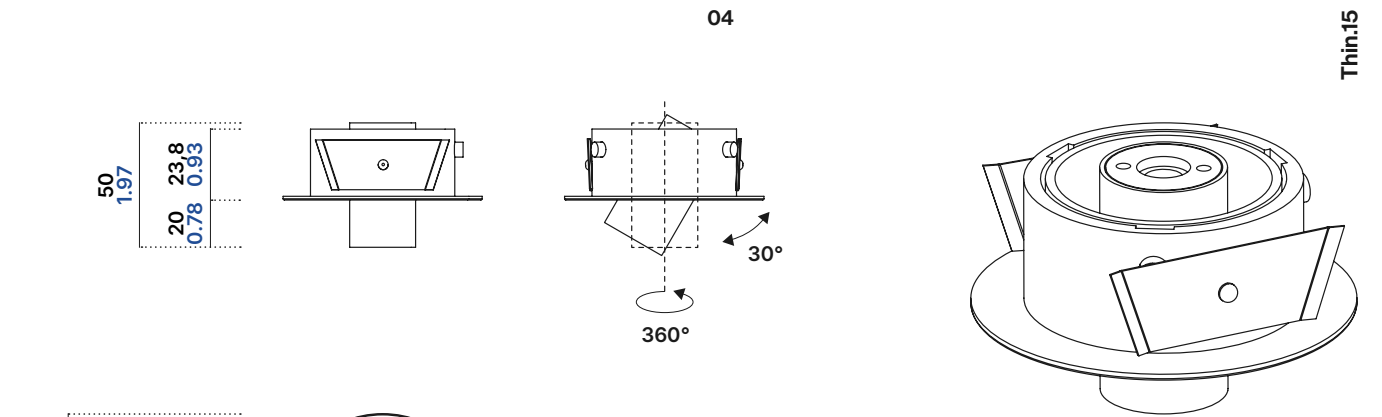
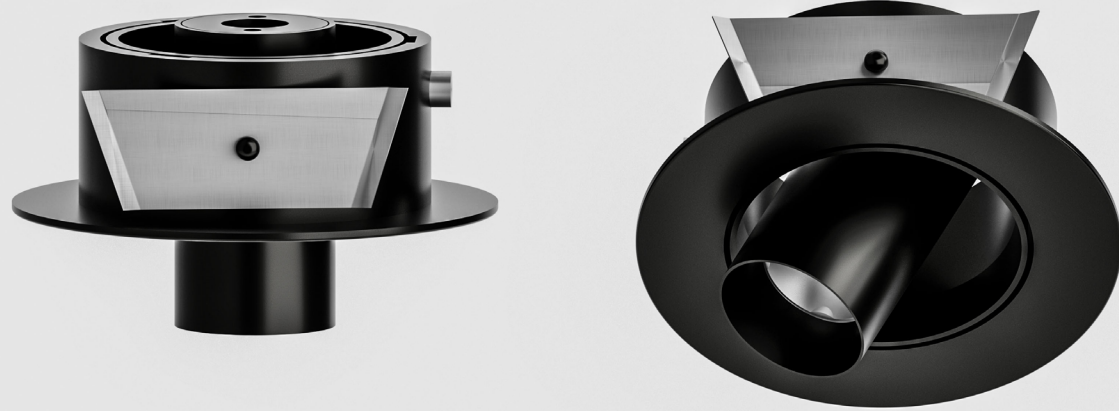

Thin:15

Weight

0.14 kg

Applications

Folio Opal

Forniture

Drywall

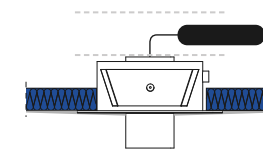
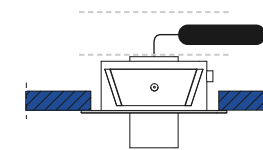
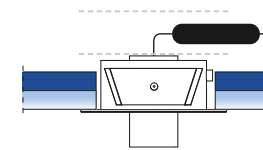

Cut out: Ø 70 mm / Ø 2.75 in



Clear volume: 30 mm / 1.18 in

Cut out: Ø 70 mm / Ø 2.75 in



Clear volume: 30 mm / 1.18 in

Cut out: Ø 70 mm / Ø 2.75 in



Clear volume: 30 mm / 1.18 in

Light.26_tilt_TL

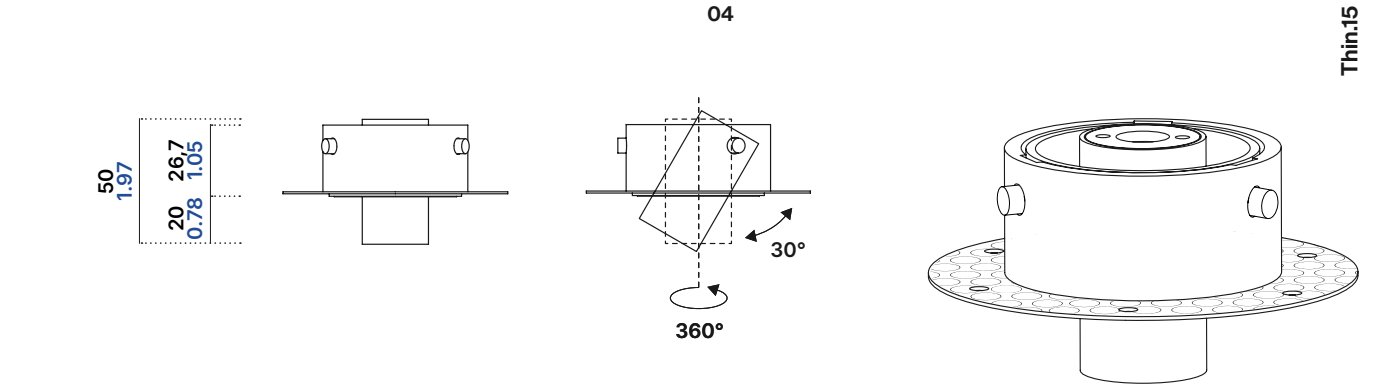
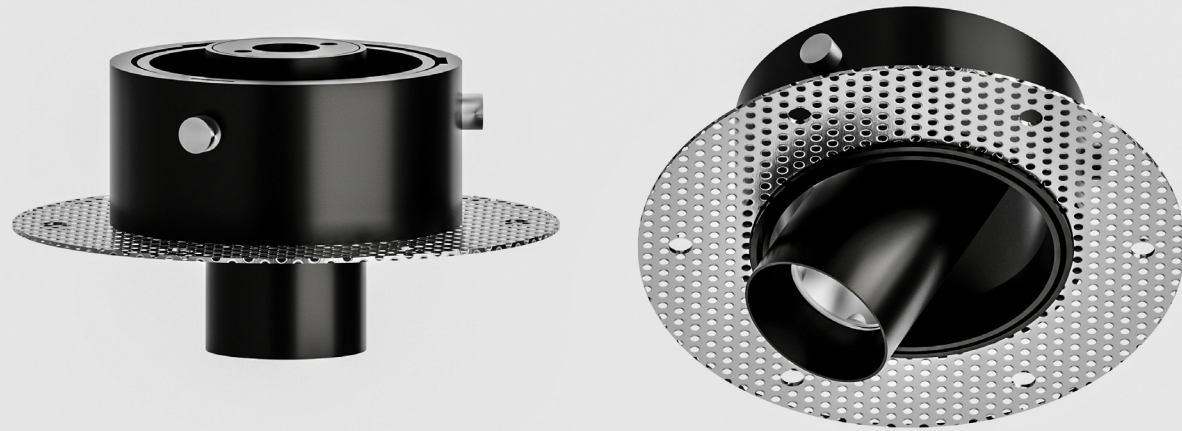

Weight

0.13 kg

Applications

Drywall

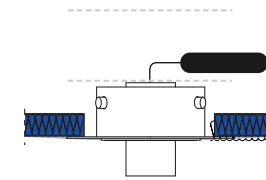

Cut out: \varnothing 70 mm / \varnothing 2.75 in



Clear volume: 30 mm / 1.18 in

Light.26_tilt_TL_on board

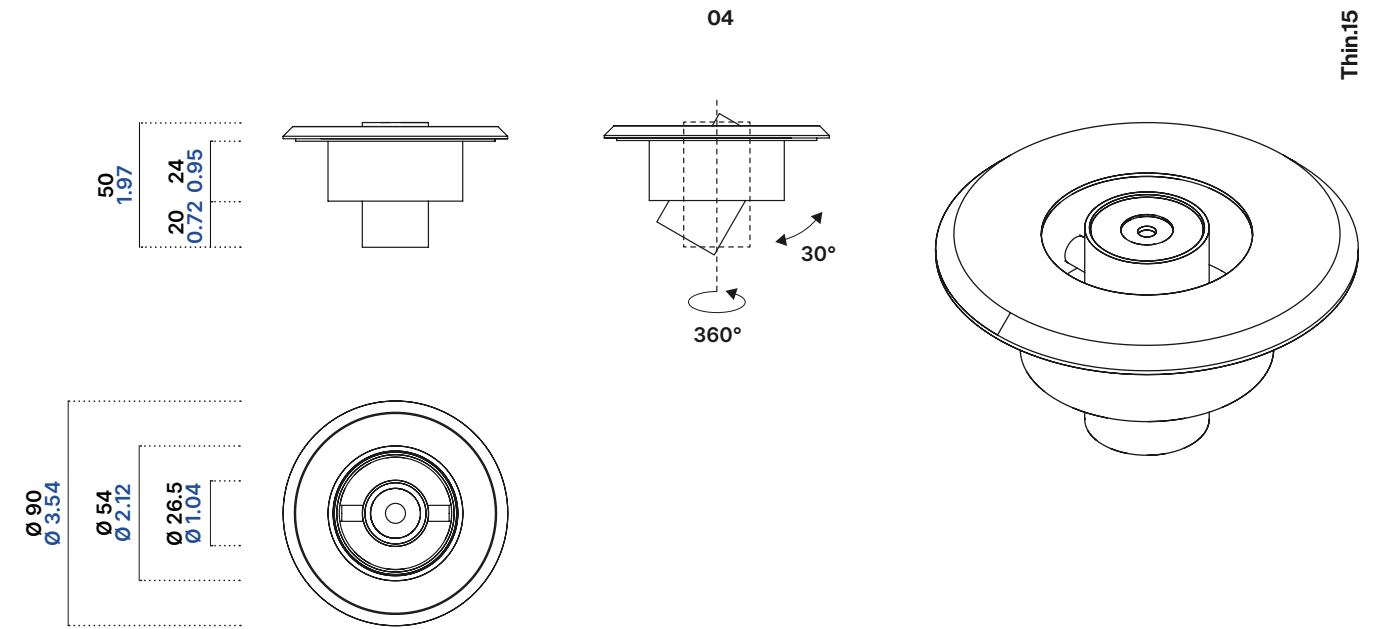

Weight

0.16 kg

Applications

Folio Opal

Other Material

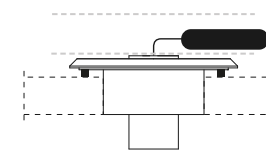
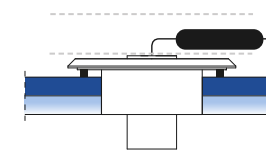

Cut out: Ø 54 mm / Ø 2.12 in



Cut out: Ø 54 mm / Ø 2.12 in



Clear volume: 30 mm / 1.18 in

Clear volume: 30 mm / 1.18 in

Light.26_track

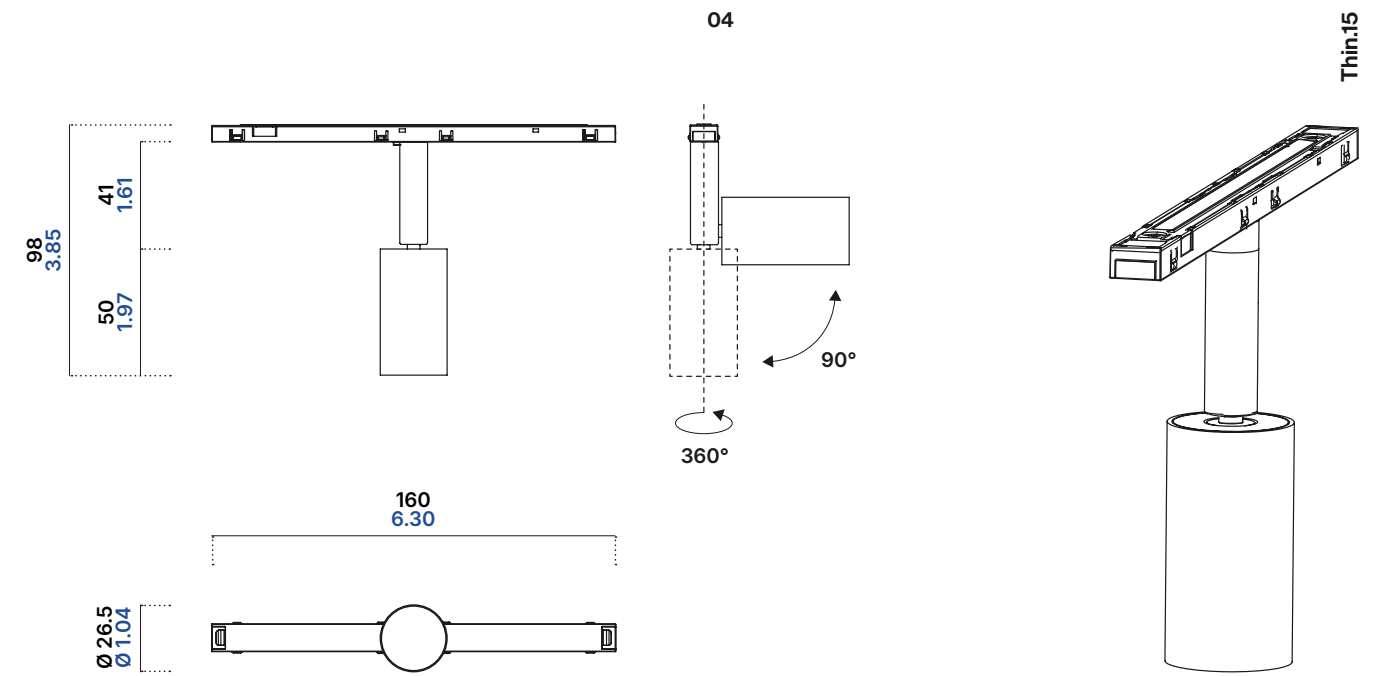

Weight

0.08 kg

Applications

Folio Opal

Forniture

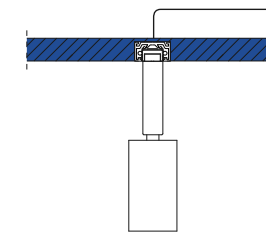
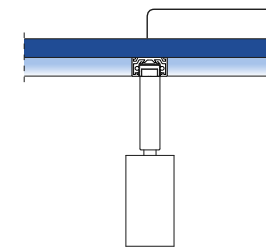

Cut out: 19x10,2 mm / 0.74x0.41 in

Cut out: 19x10,2 mm / 0.74x0.41 in



Midi.40

)04 Midi.40

High performance in a 40 mm diameter, designed for spaces requiring distinct accent lighting. Offering unprecedented installation versatility, the Midi.40 system is highly adaptable, fully supporting all three of the collection's core peculiarities: Snap-in, Trim // Trimless and Plug-in.

)Light source

LED type:	Nichia
LED Amperage:	500 mA
LED Duration:	50 000 h.
Power:	6.1 W
Delivered Lumen:	650 lm
Efficacy:	106.5 lm/W
CRI:	>90
R9:	>50
TM30:	Rf: 91 Rg: 100
SDCM:	2
Color temperature (CCT):	2700K, 3000K, 3500K, 4000K <i>on request: 2000K, 2200K, 2500K, 5000K</i>

)Optics

Optic Type:
Beam Angle (BA°):

lens

12°



19°



25°

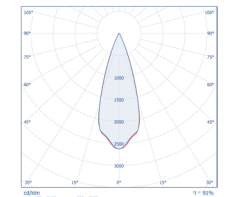
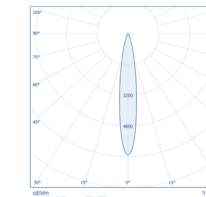
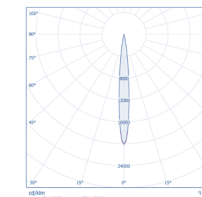

)Electrical

Voltage:	24VDC
Class:	Class 3 24V
Driver:	DC/DC 24V
Output current:	500 mA
Dimmerability:	0-10V, 1-10V, DALI, DMX, Bluetooth, PUSH



Midi.40_adj_TR_snap in

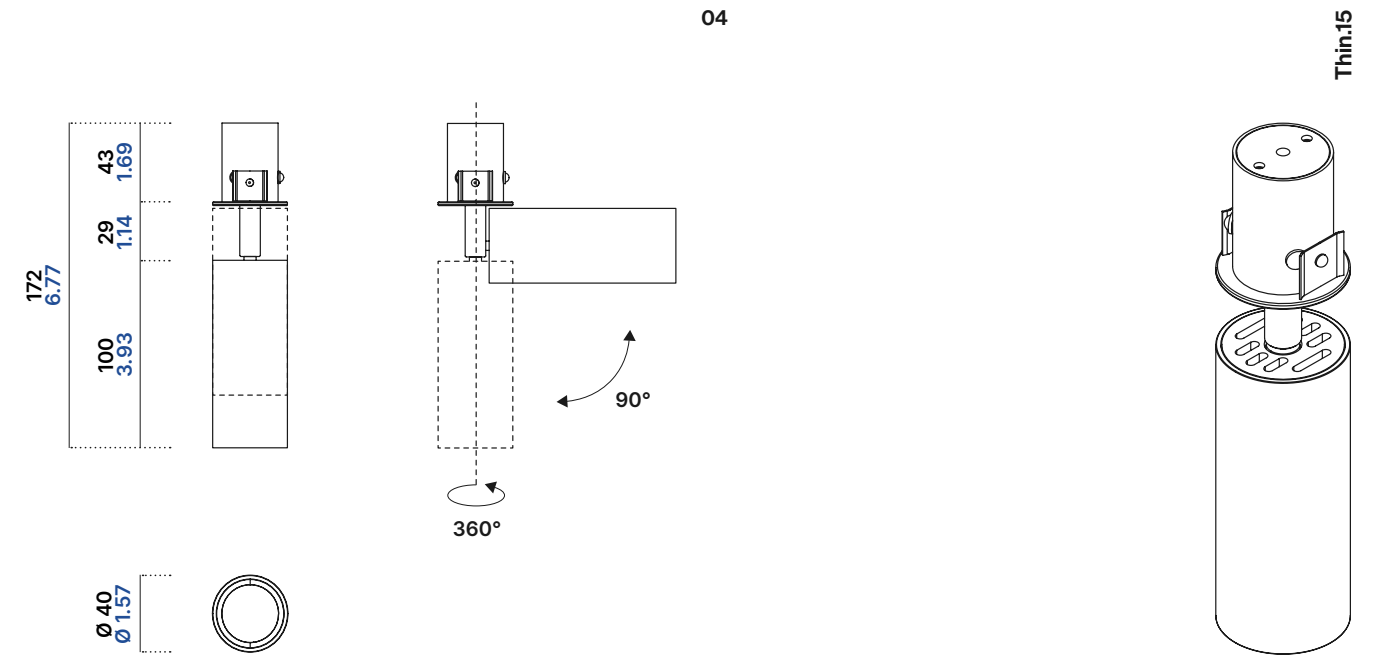

Weight

0.27 kg

Applications

Folio Opal

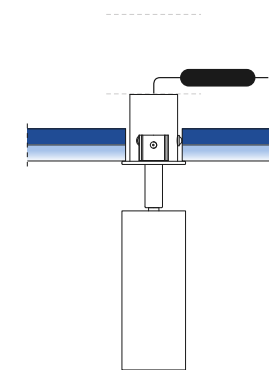

Cut out: Ø 35 mm / Ø 1.37 in



Clear volume: 50 mm / 1.96 in

Folio Zero

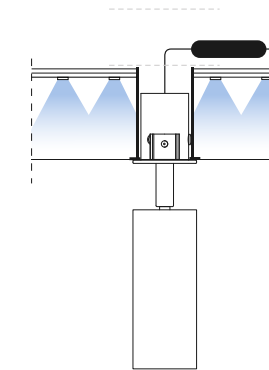

Cut out: Ø 35 mm / Ø 1.37 in



Clear volume: 50 mm / 1.96 in

Forniture

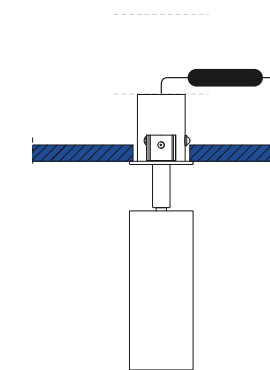

Cut out: Ø 35 mm / Ø 1.37 in



Clear volume: 50 mm / 1.96 in

Drywall

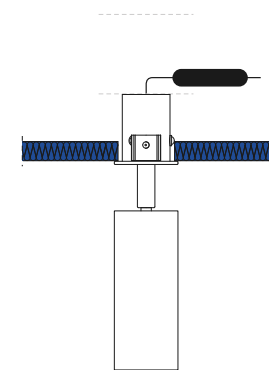

Cut out: Ø 35 mm / Ø 1.37 in



Clear volume: 50 mm / 1.96 in

Peculiarities

Snap-in

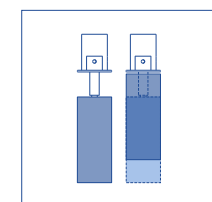

Trim // Trimless

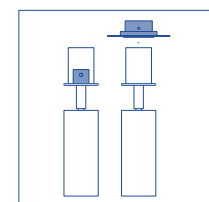

www.folio.it > Menu > Download > Datasheet > Datasheet Spot.Mate

03.01 Midi.40_adj_TR_snap in

Midi.40_adj_TL

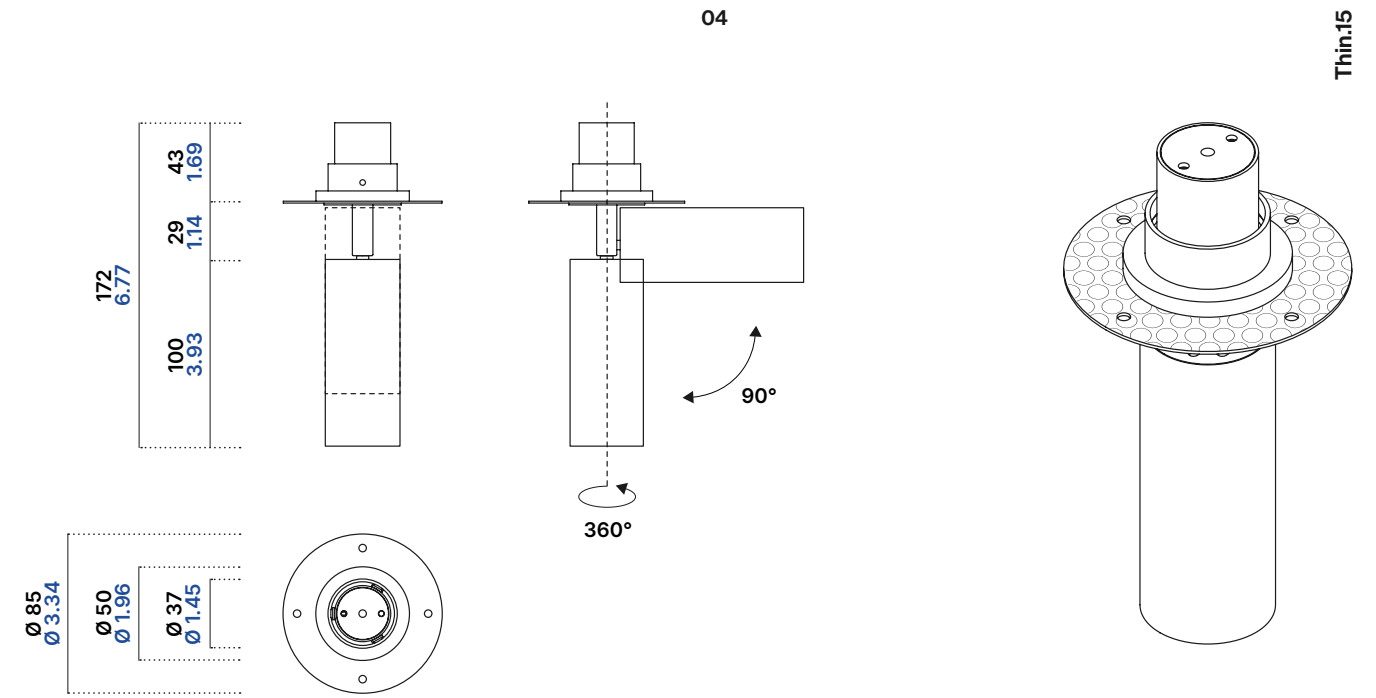

Weight

0.27 kg

Applications

Drywall

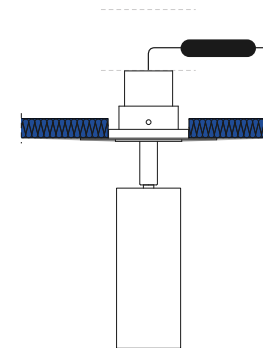

Cut out: 52 mm / 2.04 in



Clear volume: 50 mm / 1.96 in

Peculiarities

Trim // Trimless

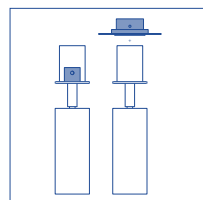

www.folio.it > Menu > Download > Datasheet > Datasheet Spot.Mate

03.02 Midi.40_adj_TL

Midi.40_adj_TL_plug in_on board

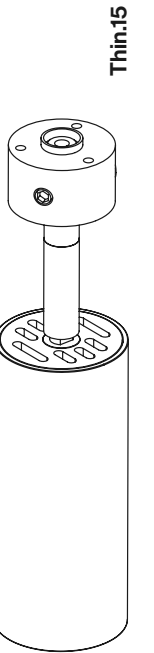
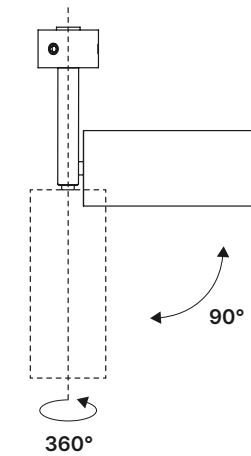
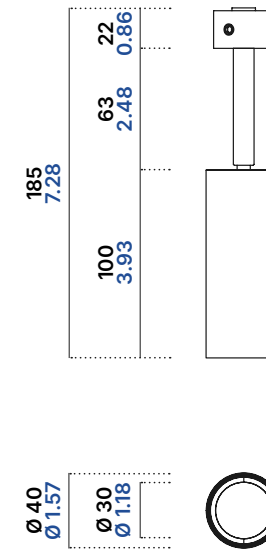

Thin:15

04

Weight

0.18 kg

Applications

Folio Opal

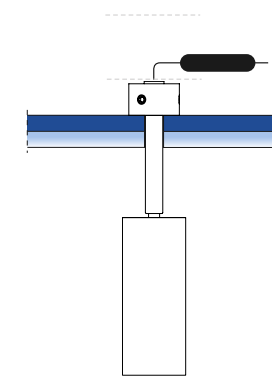

Cut out: \varnothing 11,5 mm / \varnothing 0.45 in



Clear volume: 40 mm / 1.57 in

Folio Zero

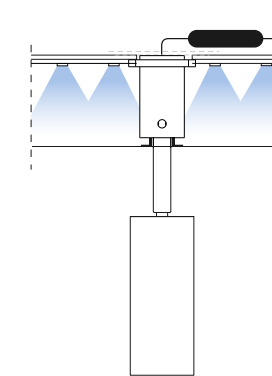

Cut out: \varnothing 11,5 mm / \varnothing 0.45 in



Clear volume: 40 mm / 1.57 in

Other Material

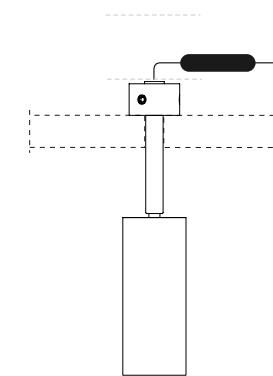

Cut out: \varnothing 11,5 mm / \varnothing 0.45 in



Clear volume: 40 mm / 1.57 in

Peculiarities

Plug-in

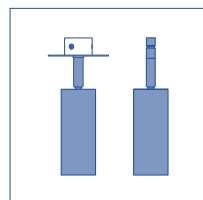

www.folio.it > Menu > Download > Datasheet > Datasheet Spot.Mate

03.03 Midi.40_adj_TL_plug in_on board

Midi.40_adj_TL_plug in

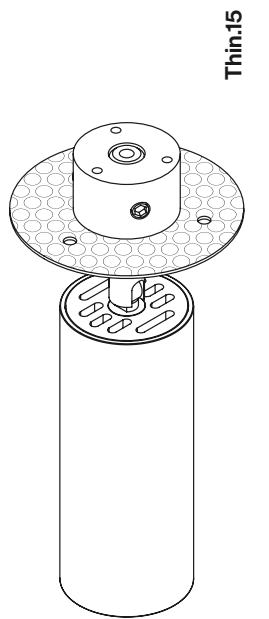
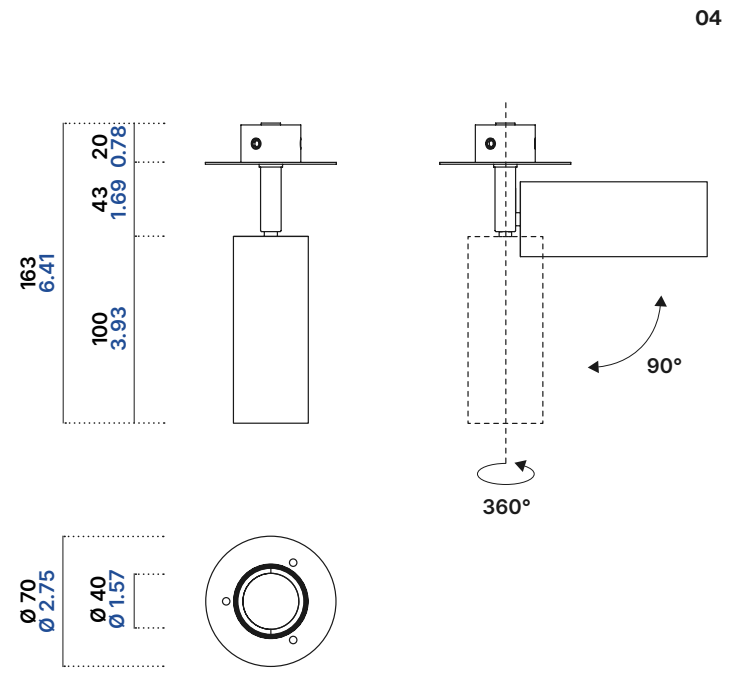

Thin:15

)Weight

0.16 kg

)Applications

Drywall

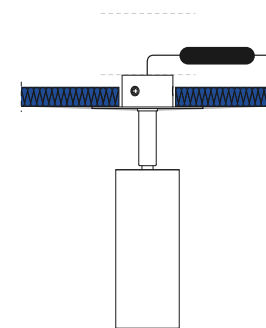

Cut out: \varnothing 35 mm / \varnothing 1.37 in



Clear volume: 40 mm / 1.57 in

)Peculiarities

Plug-in

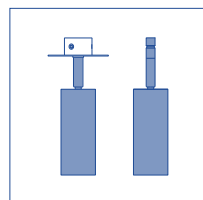

www.folio.it > Menu > Download > Datasheet > Datasheet Spot.Mate

03.04 Midi.40_adj_TL_plug in

Midi.40_adj_recessed

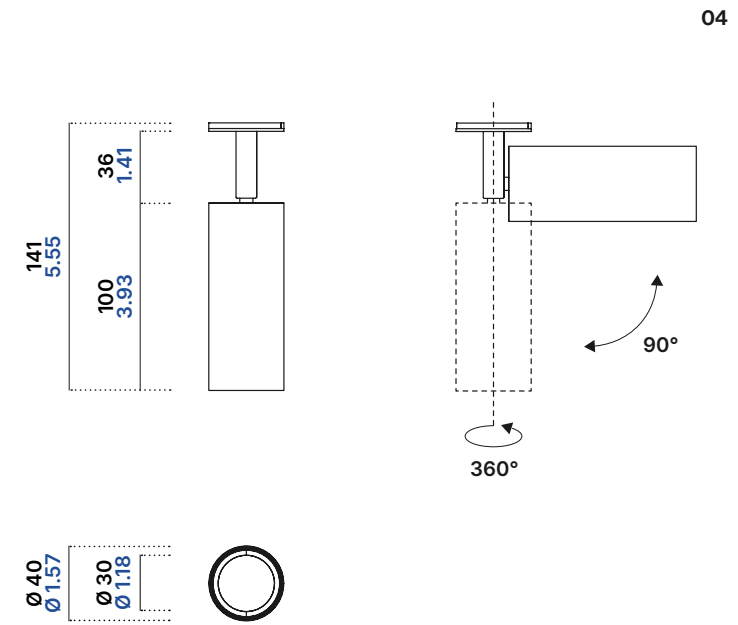

Weight

0.12 kg

Applications

Furniture

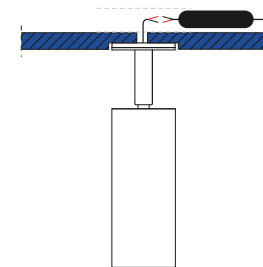

Cut out: Ø 40,5 mm, thk 4 mm / Ø 1.59 in, thk 0.15 in



Clear volume: 15 mm / 0.59 in

Midi.40_adj_TR_snap in_on board

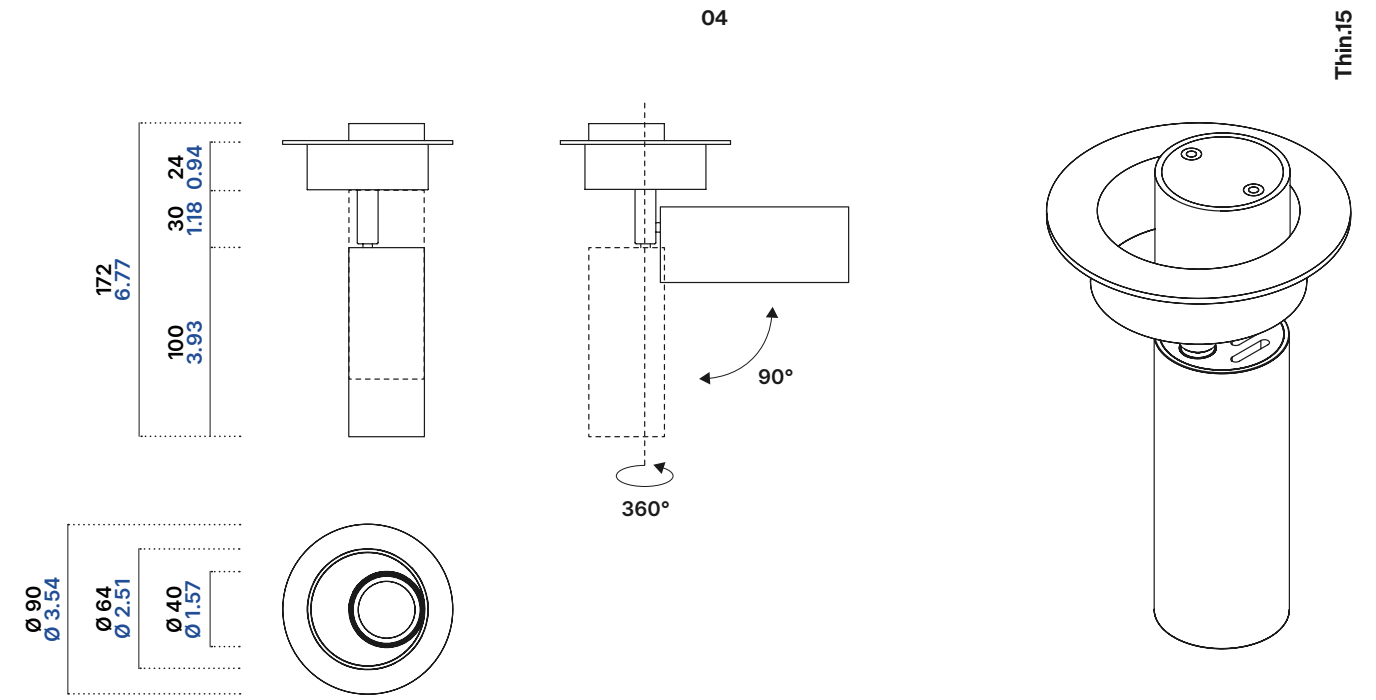

Thin:15

Weight

0.31 kg

Applications

Folio Opal

Other Material

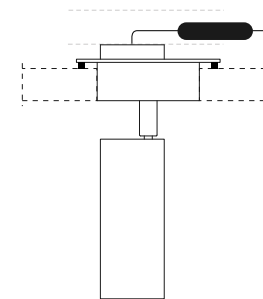
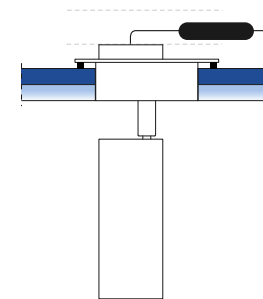

Cut out: Ø 54 mm / Ø 2.12 in



Clear volume: 20 mm / 0.78 in

Cut out: Ø 54 mm / Ø 2.12 in



Clear volume: 20 mm / 0.78 in

Peculiarities

Snap-in

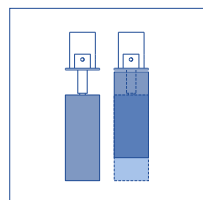

www.folio.it > Menu > Download > Datasheet > Datasheet Spot.Mate

03.06 Midi.40_adj_TR_snap in_on board



Midi.40_tilt_TR

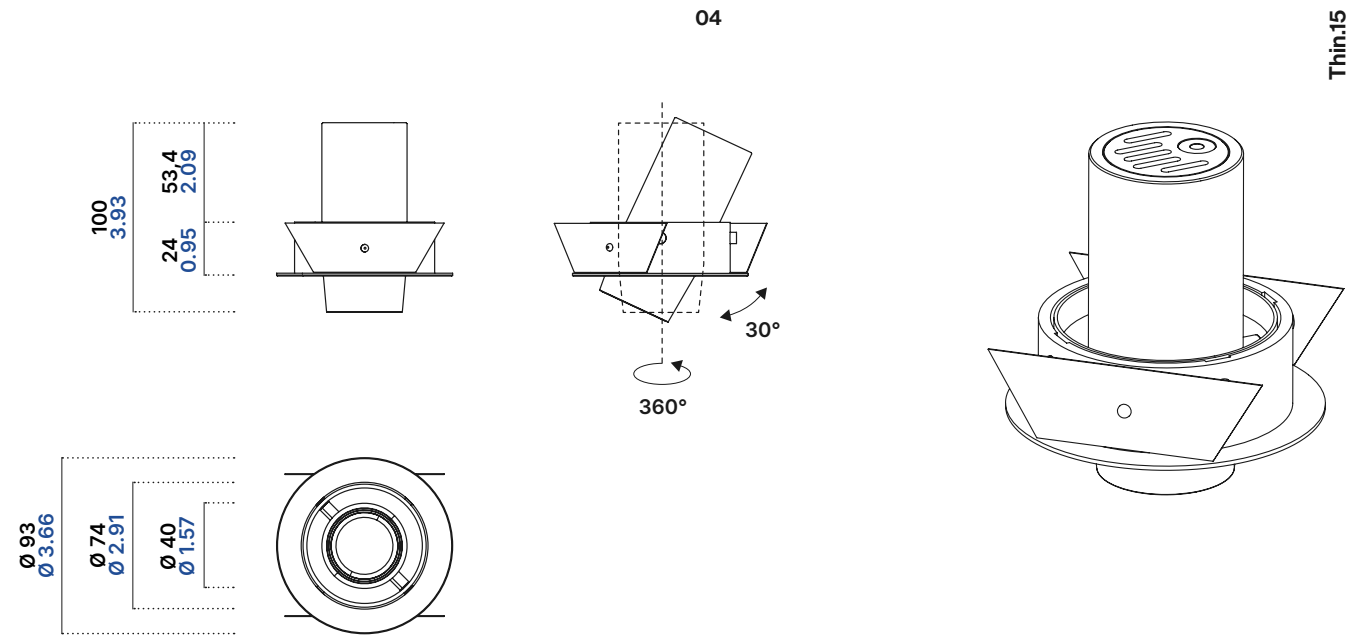
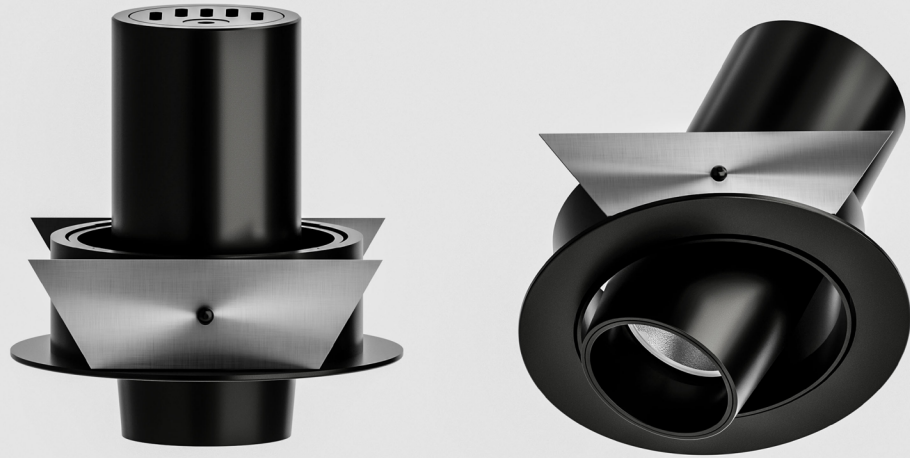

Weight

0.35 kg

Applications

Folio Opal

Forniture

Drywall

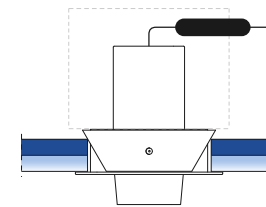

Cut out: Ø 85 mm / Ø 3.34 in



Clear volume: 75x100 mm / 2.95x3.93 in

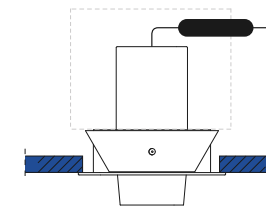

Cut out: Ø 85 mm / Ø 3.34 in



Clear volume: 75x100 mm / 2.95x3.93 in

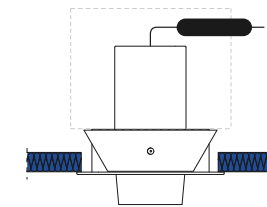

Cut out: Ø 85 mm / Ø 3.34 in



Clear volume: 75x100 mm / 2.95x3.93 in

Midi.40_tilt_TL

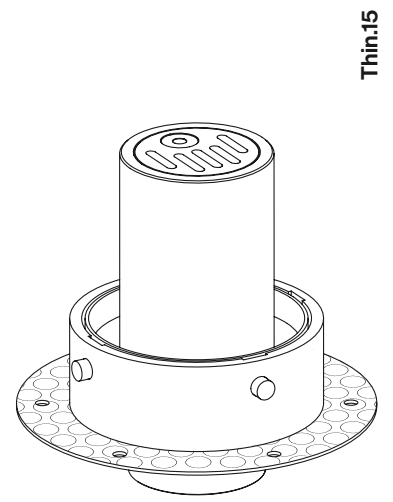
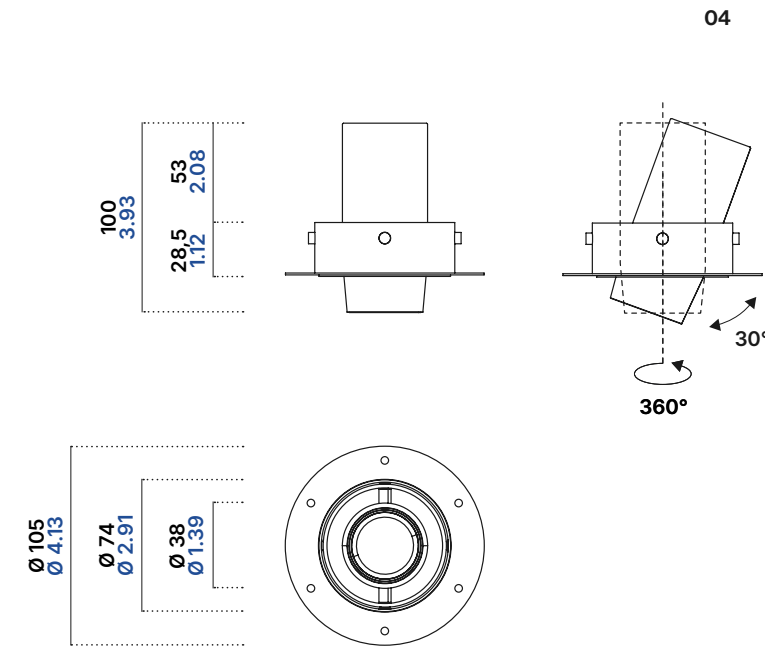
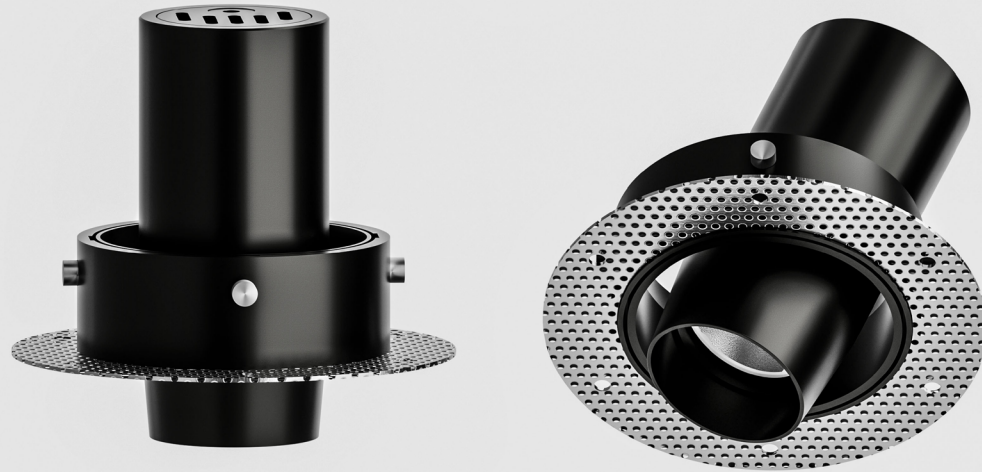

Thin:15

Weight

0.35 kg

Applications

Drywall

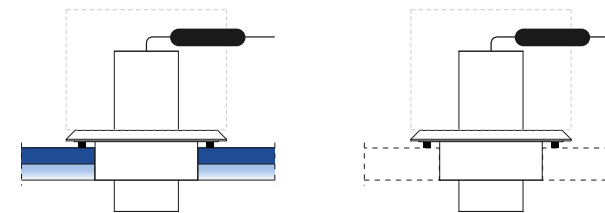

Cut out: \varnothing 85 mm / \varnothing 3.34 in



Clear volume: 75x100 mm / 2.95x3.93 in



www.folio.it > Menu > Download > Datasheet > Datasheet Spot.Mate

03.08 Midi.40_tilt_TL

Midi.40_tilt_TL_on board

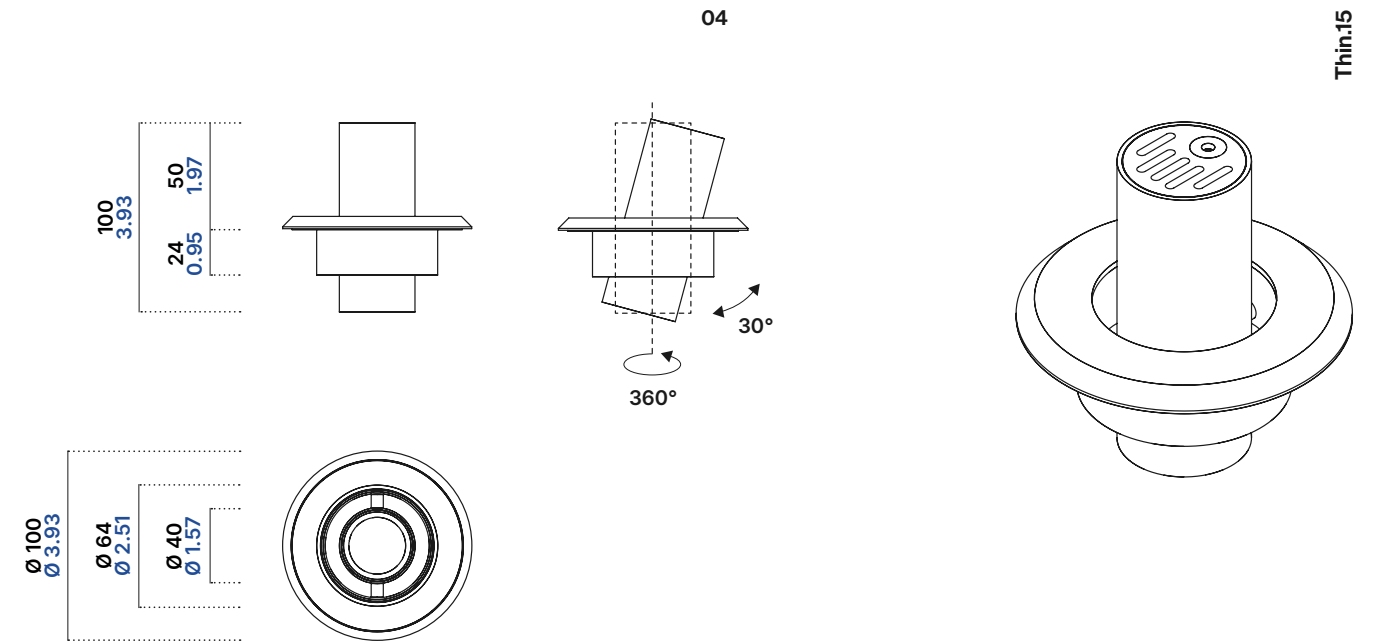

Weight

0.35 kg

Applications

Folio Opal

Other Material

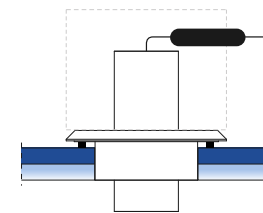

Cut out: \varnothing 64 mm / \varnothing 2.51 in



Clear volume: 70x100 mm / 2.75x3.93 in

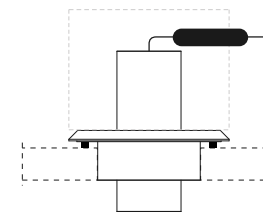

Cut out: \varnothing 64 mm / \varnothing 2.51 in



Clear volume: 70x100 mm / 2.75x3.93 in

Midi.40_track

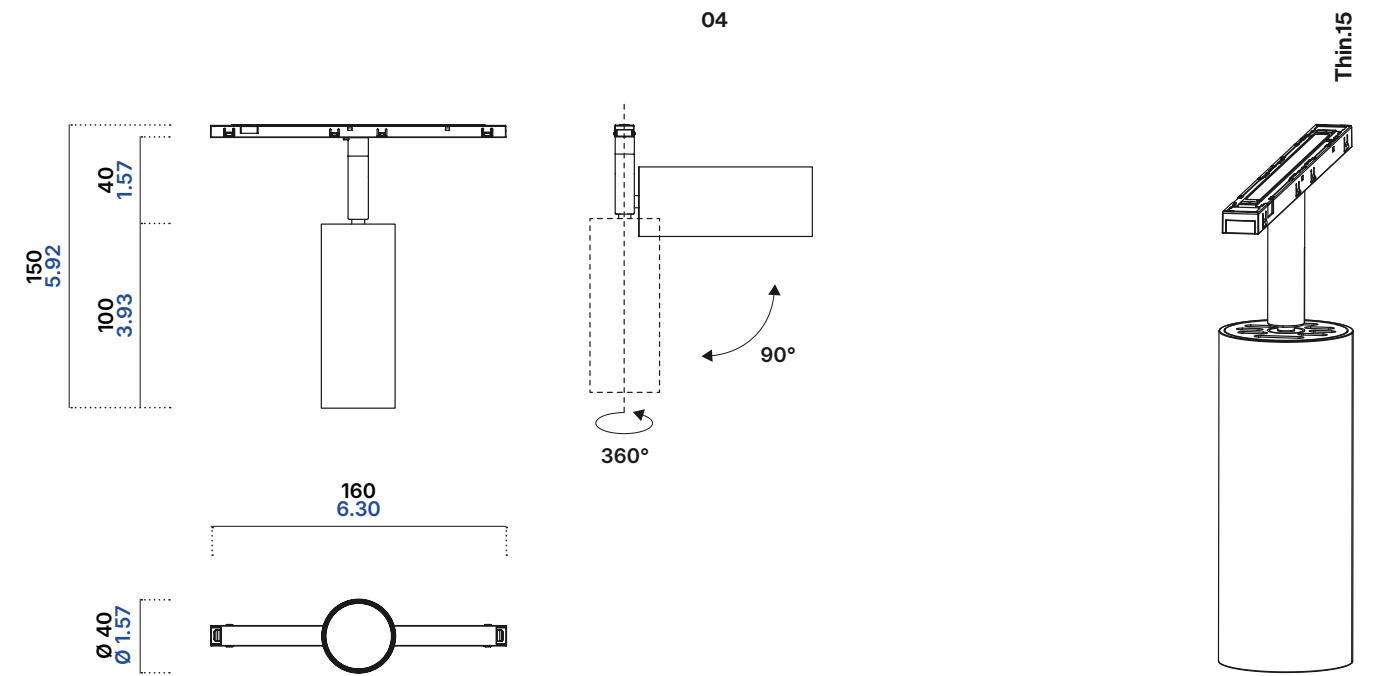

Weight

0.21 kg

Applications

Folio Opal

Forniture

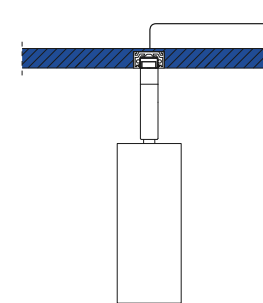
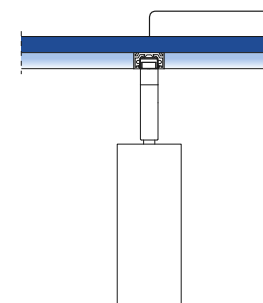

Cut out: 19x10,2 mm / 0.74x0.41 in



Cut out: 19x10,2 mm / 0.74x0.41 in



www.folio.it > Menu > Download > Datasheet > Datasheet Spot.Mate

03.09 Midi.40_track

Bold.62



The ultimate expression of power in the collection, this 62 mm diameter system is engineered for large spaces and designed to deliver the highest lumen output. Ensuring total functional freedom, the Bold.62 integrates all three of the collection's advanced peculiarities, Snap-in, Trim // Trimless, and Plug-in, allowing the light to adapt dynamically and powerfully to the architecture.

)Light source

LED type:	Nichia
LED Amperage:	350 mA
LED Duration:	50 000 h.
Power:	12 W
Delivered Lumen:	1150 lm
Efficacy:	95.8 lm/W
CRI:	>90
R9:	>50
TM30:	Rf: 98 Rg: 99
SDCM:	3
Color temperature (CCT):	2700K, 3000K, 3500K, 4000K on request: 2000K, 2200K, 2500K, 5000K

)Optics

Optic Type:
Beam Angle (BA°):

lens

12°

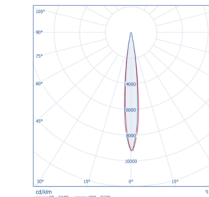

35°

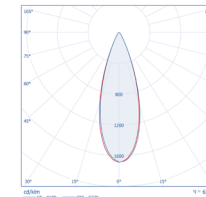

55°

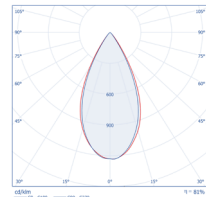

)Electrical

Voltage:	48VDC
Class:	Class 3 48V
Driver:	DC/DC 48V
Output current:	350 mA
Dimmerability:	0-10V, 1-10V, DALI, DMX, Bluetooth, PUSH



Bold.62_adj_TR_snap in

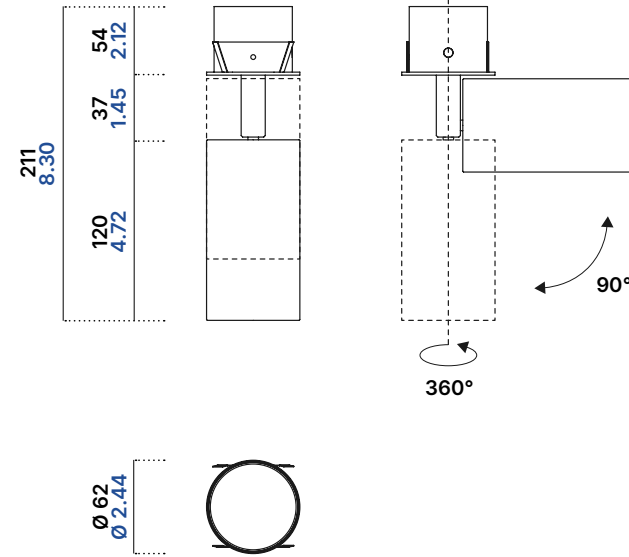

07

Bold.62

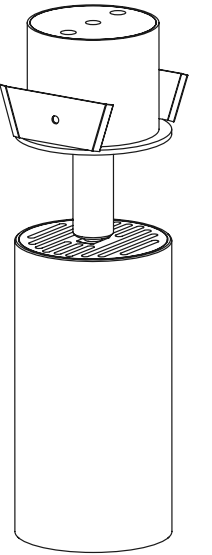

Weight

0.65 kg

Applications

Folio Opal

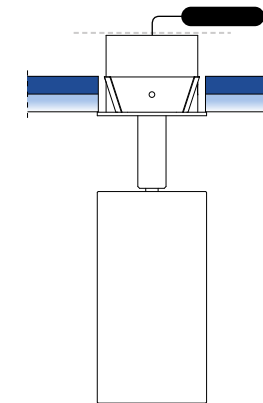

Cut out: 9.5 mm / 3.74 in



Clear volume: 20 mm / 7.87 in

Folio Zero

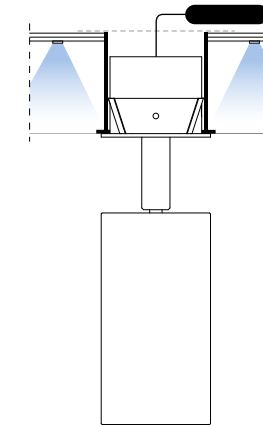

Cut out: 9.5 mm / 3.74 in



Clear volume: 20 mm / 7.87 in

Forniture

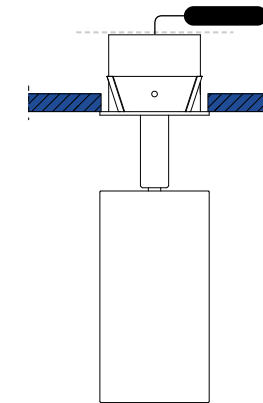

Cut out: 9.5 mm / 3.74 in



Clear volume: 20 mm / 7.87 in

Drywall

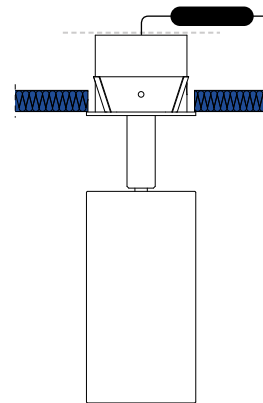

Cut out: 9.5 mm / 3.74 in



Clear volume: 20 mm / 7.87 in

Peculiarities

Snap-in

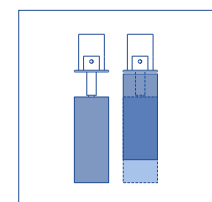

Trim // Trimless

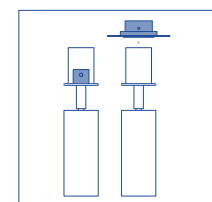

www.folio.it > Menu > Download > Datasheet > Datasheet Spot.Mate

04.01 Bold.62_adj_TR_snap in

Bold.62_adj_TL_snap in

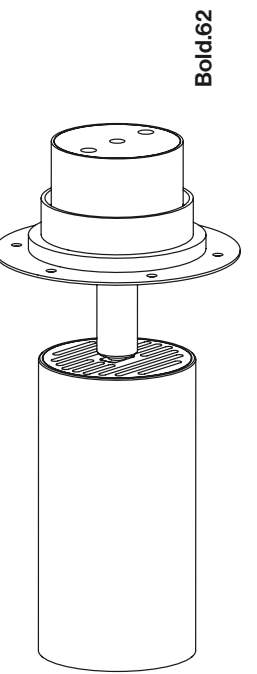
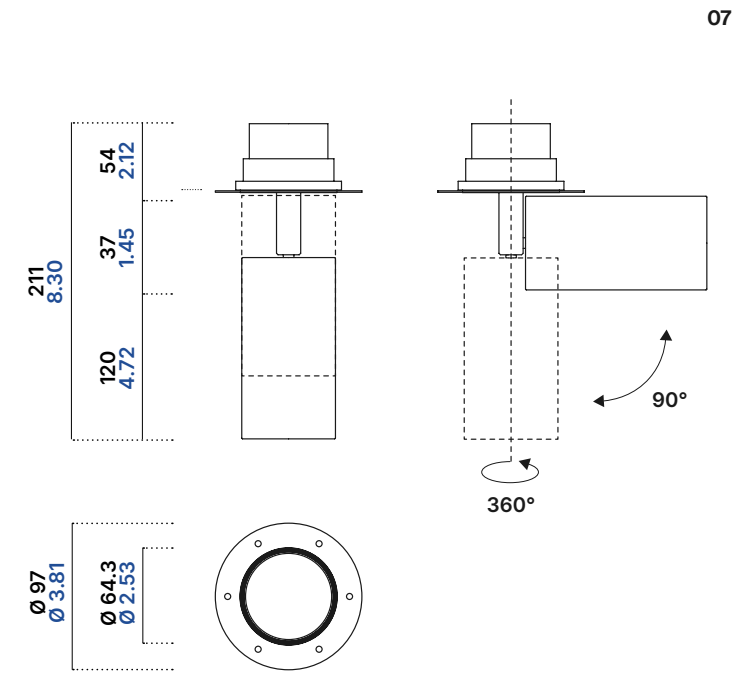

Bold.62

Weight

0.68 kg

Applications

Drywall

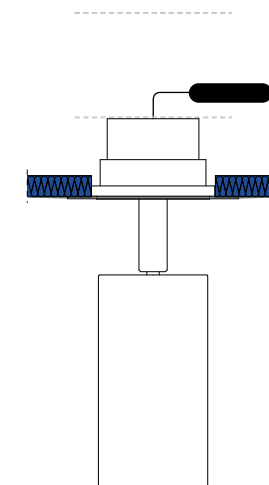

Cut out: 9.5 mm / 3.74 in



Clear volume: 20 mm / 7.87 in

Peculiarities

Snap-in

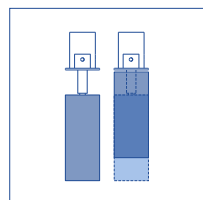

Trim // Trimless

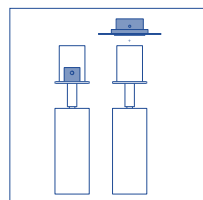

www.folio.it > Menu > Download > Datasheet > Datasheet Spot.Mate

04.02 Bold.62_adj_TL_snap in

Bold.62_adj_TL_plug in_on board

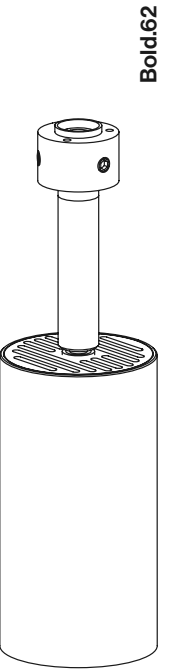
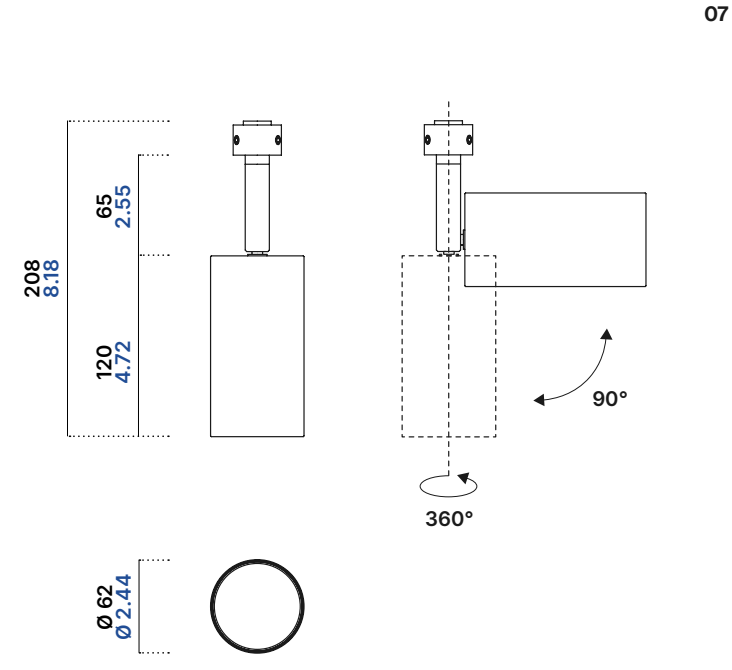

)Weight

0.45 kg

)Applications

Folio Opal

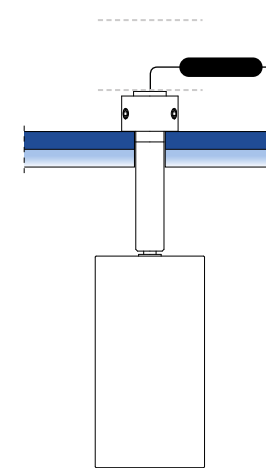

Cut out: 9.5 mm / 3.74 in



Clear volume: 20 mm / 7.87 in

Folio Zero

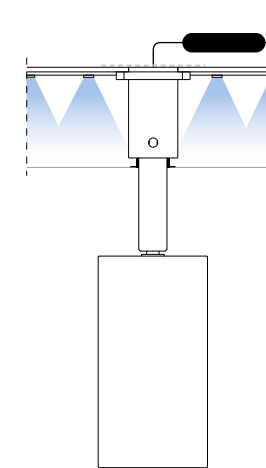

Cut out: 9.5 mm / 3.74 in



Clear volume: 20 mm / 7.87 in

Other materials

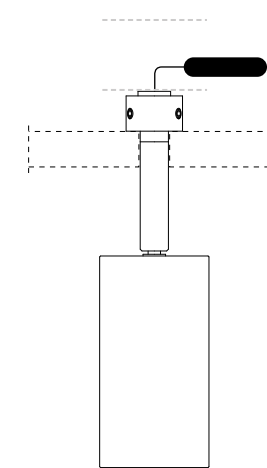

Cut out: 9.5 mm / 3.74 in



Clear volume: 20 mm / 7.87 in

)Peculiarities

Plug-in

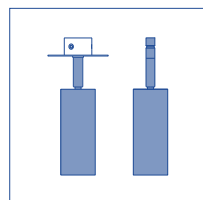

www.folio.it > Menu > Download > Datasheet > Datasheet Spot.Mate

04.03 Bold.62_adj_TL_plug in_on board

Bold.62_adj_TL_plug in



07

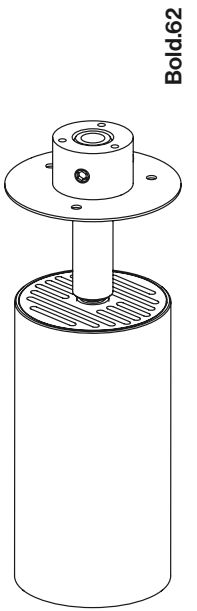
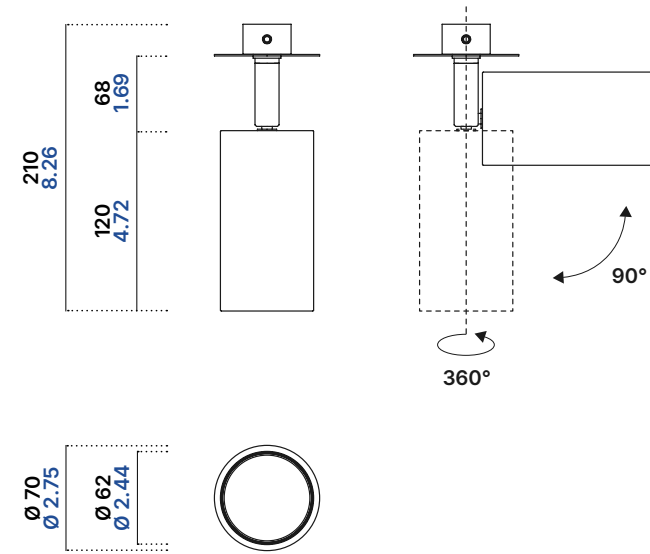

Bold.62

)Weight

0.45 kg

)Applications

Drywall

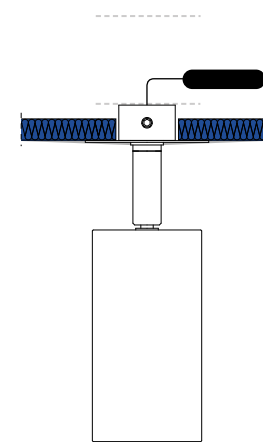

Cut out: 9.5 mm / 3.74 in



Clear volume: 20 mm / 7.87 in

)Peculiarities

Plug-in

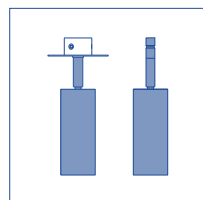

www.folio.it > Menu > Download > Datasheet > Datasheet Spot.Mate

04.04 Bold.62_adj_TL_plug in

Bold.62_adj_TL_snap in_on board

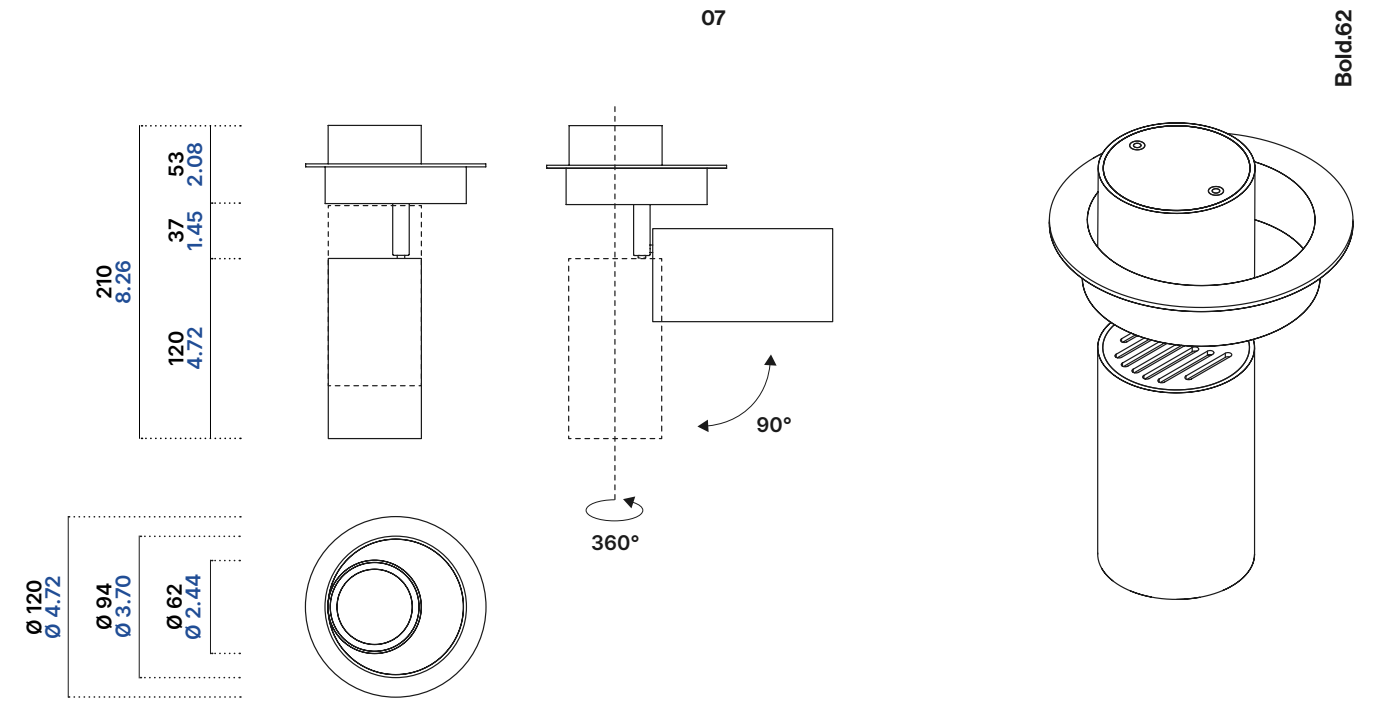
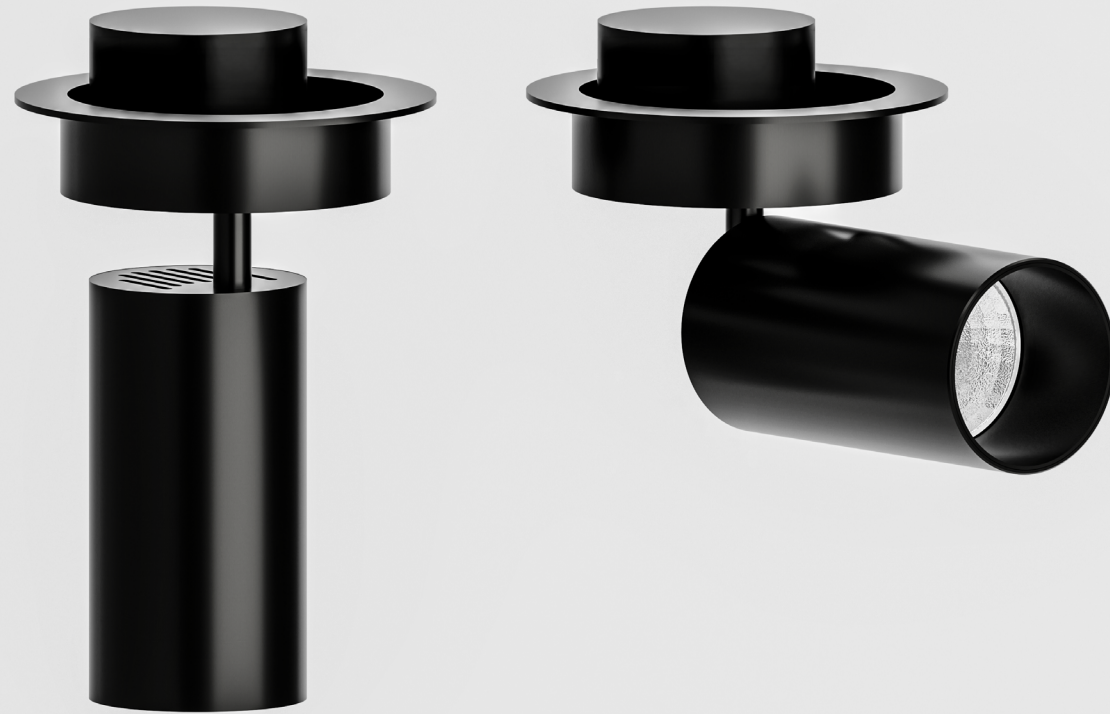

Bold.62

Weight

0.70 kg

Applications

Folio Opal

Other materials

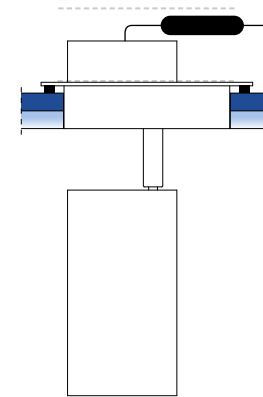

Cut out: 9.5 mm / 3.74 in



Clear volume: 20 mm / 7.87 in

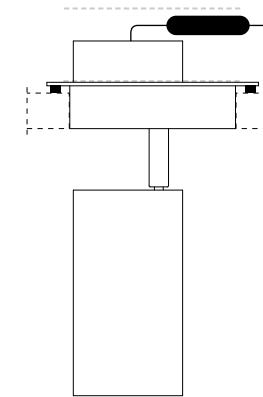

Cut out: 9.5 mm / 3.74 in



Clear volume: 20 mm / 7.87 in

Peculiarities

Snap-in

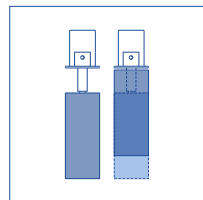

www.folio.it > Menu > Download > Datasheet > Datasheet Spot.Mate

04.05 Bold.62_adj_TL_snap in_on board

Material integration

Folio Opal

Edge lighting system

Thin.15	Ø 15 mm	1.5 W
Light.26	Ø 26 mm	2.1 W
Midi.40	Ø 40 mm	6.1 W
Bold.62	Ø 62 mm	12 W



Thin.15_adj_TR

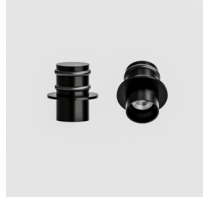

Thin.15_fix_TR



Thin.15_fix_TL



Thin.15_track

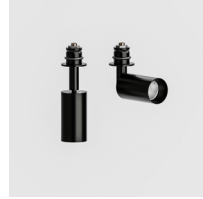

Light.26_adj_TR



Light.26_adj_TL_plug in_on board



Light.26_adj_TL_snap in_on board



Light.26_tilt_TR



Light.26_tilt_TL_on board



Light.26_track

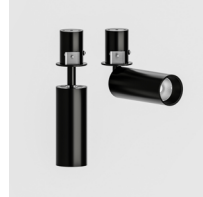

Midi.40_adj_TR_snap in

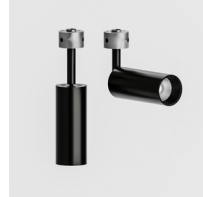

Midi.40_adj_TL_plug in_on board



Midi.40_adj_TL_snap in_on board



Midi.40_tilt_TR



Midi.40_tilt_TL_on board



Midi.40_track



Bold.62_adj_TR_snap in

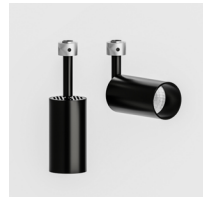

Bold.62_adj_TL_plug in_on board



Bold.62_adj_TL_snap in_on board

Folio Zero

Stretch fabric system

Thin.15	Ø 15 mm	1.5 W
Light.26	Ø 26 mm	2.1 W
Midi.40	Ø 40 mm	6.1 W
Bold.62	Ø 62 mm	12 W



Thin.15_adj_TR

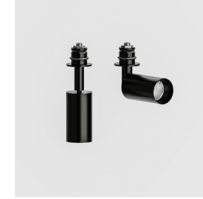

Light.26_adj_TR

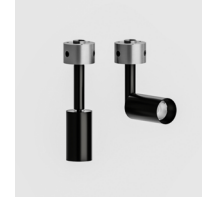

Light.26_adj_TL_plug in_on board

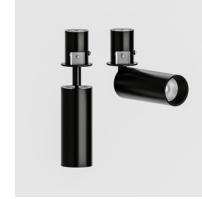

Midi.40_adj_TR_snap in

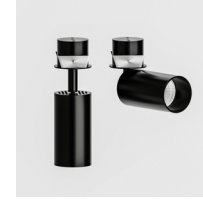

Bold.62_adj_TR_snap in

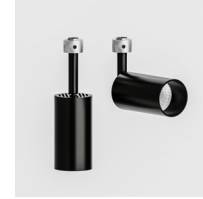

Bold.62_adj_TL_plug in_on board

Forniture

Thin.15	Ø 15 mm	1.5 W
Light.26	Ø 26 mm	2.1 W
Midi.40	Ø 40 mm	6.1 W
Bold.62	Ø 62 mm	12 W



Thin.15_adj_TR Thin.15_fix_TR Thin.15_fix_TL Thin.15_track Light.26_adj_TR Light.26_adj_TL_recessed



Light.26_tilt_TR Light.26_track Midi.40_adj_TR_snap in Midi.40_adj_TL_plug in_on board Midi.40_adj_TL_recessed Midi.40_tilt_TR



Midi.40_track Bold.62_adj_TR_snap in

Drywall

Thin.15	Ø 15 mm	1.5 W
Light.26	Ø 26 mm	2.1 W
Midi.40	Ø 40 mm	6.1 W
Bold.62	Ø 62 mm	12 W

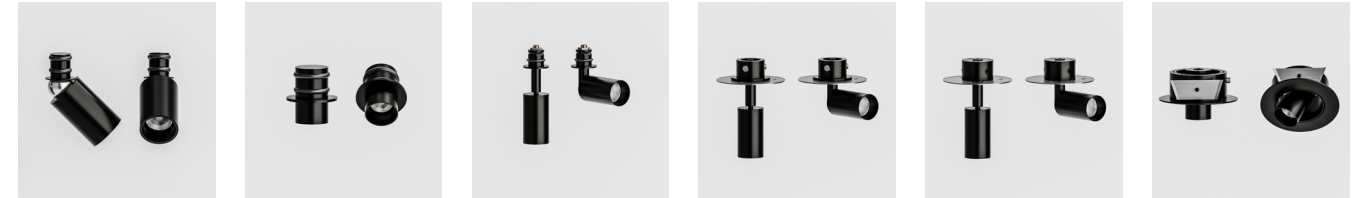

Thin.15_adj_TR Thin.15_fix_TR Light.26_adj_TR Light.26_adj_TL Light.26_adj_TL_plug in Light.26_tilt_TR



Light.26_tilt_TL Midi.40_adj_TL_snap in Midi.40_adj_TR_snap in Midi.40_adj_TL_plug in_on board Midi.40_adj_TL_plug in Midi.40_tilt_TR



Midi.40_tilt_TL Bold.62_adj_TR_snap in Bold.62_adj_TL_snap in Bold.62_adj_TL_plug in

Other materials

Thin.15	Ø 15 mm	1.5 W
Light.26	Ø 26 mm	2.1 W
Midi.40	Ø 40 mm	6.1 W
Bold.62	Ø 62 mm	12 W



Light.26_adj_TL_plug
in_on board



Light.26_adj_TL_snap
in_on board



Light.26_tilt_TL_
on board

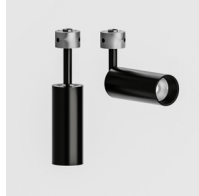

Midi.40_adj_TL_plug in
_on board



Midi.40_adj_TL_snap
in_on board



Midi.40_tilt_TL_on
board



Bold.62_adj_TL_plug
in_on board



Bold.62_adj_TL_snap
in_on board

Spot.Mate



Cifralluminio S.r.l.

Via Romolo Gessi, 10
25135 Brescia - Italy

+39 030 3363047
+39 030 3363819

info@folio.it

www.folio.it
[@folio_lighting](https://www.instagram.com/folio_lighting)



Folio Spot.Mate 2026